



# SERIOUS THEFT PROTECTION



## SAFEGUARD YOUR SERIOUS GEAR



TUFFY PROFESSIONAL LINE CATALOG - 14  
PRO.TUFFYPRODUCTS.COM | 866.318.8339





# SERIOUS THEFT PROTECTION FOR SERIOUS GEAR

## PROFESSIONAL AGENCIES & FLEET CATALOG

- LOCKING SYSTEM OVERVIEW ..... 3
- TACTICAL GEAR SECURITY DRAWERS ..... 4
- TACTICAL GEAR SECURITY DRAWERS ACCESSORIES ..... 6
- UNIVERSAL CARGO SECURITY ..... 9
- UNDER SEAT LOCK BOXES ..... 10
- SECURITY CONSOLE INSERTS ..... 16
- SECURITY CONSOLES ..... 24
- HEAVY DUTY TRUCK BED DRAWERS ..... 26
- PORTABLE SECURITY SOLUTIONS ..... 28
- TACTICAL GEAR SECURITY LOCK BOXES ..... 30
- SECURITY DRAWERS ..... 32
- ACCESSORIES ..... 33
- OUR STORY ..... 35



Contract Holder  
GS-30F-0031V



Scan this code to access  
**PRO.TUFFYPRODUCTS.COM**  
on your smartphone



## DON'T BECOME YOUR OWN CRIME SCENE

Law Enforcement vehicle break-ins are on the rise

• "A thief stole a Dallas SWAT officer's weapons and other items..."  
-Kevin B, myfoxdfw.com

• "We're not immune from crime like anybody else,"  
Phoenix police Detective Tony M"  
-Lindsey C. The Arizona Republic

• "Officials said a total of three SWAT vehicles have been burglarized in the past six months" [in Dallas].  
-Kevin B, myfoxdfw.com

Cargo organization poses a safety problem

• "Investigations of the tragic deaths of at least 14 law enforcement officers...identified unsafe trunk-packing as the cause or a contributing factor in two-thirds of these deaths."  
-Richard A, The Police Chief

## TUFFY'S SOLUTIONS

Provide superior protection against theft.

Enable safe cargo management.

Increase gear accessibility.

Flexible keyless lock entry for multiple users.



Contract Holder  
GS-30F-0031V



MADE IN THE USA

## HIGHER SECURITY LOCKING SYSTEM



Tuffey offers higher security with the new 10 tumbler, double bitted key and the patented Anti-twist push-button lock.

The Pry Guard II patented latch mechanism allows the box to latch shut without being locked and offers tremendous strength compared to other latches with its 1/4" thick metal components and welded steel striker.

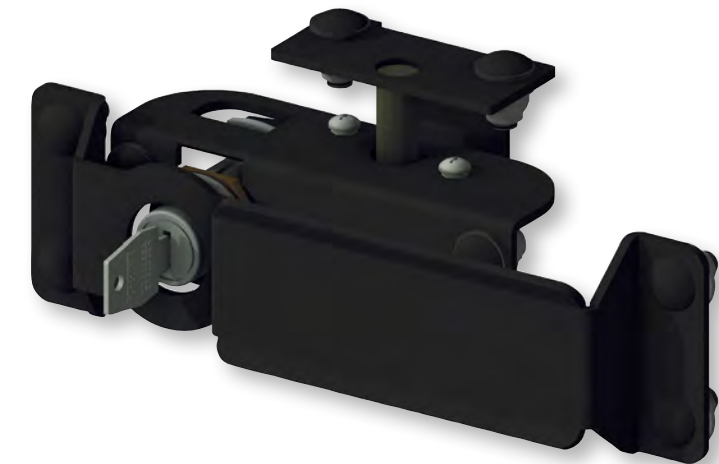

The keyless entry combination lock option offers ultimate flexibility when incorporated with the Pry-Guard II locking system

Cam-Lock security is provided by a dead bolt hooking effect which eliminates the force applied to the actual cam-lock components.



# TACTICAL GEAR SECURITY DRAWERS

Tuffy tactical gear drawers are so durable they outlast our vehicles. -Sgt. Nate Harris, La Plata County Sheriff



These Tactical Gear Security drawers are the culmination of almost three decades of precision engineering. Effortlessly access your heavy gear by opening the drawer smoothly on Tuffy's exclusive stainless steel slide system. The drawer slides have exclusive roller-stop features engineered into the slides to protect the user from unexpected shifts during normal operation.

Our patented locking system provides security when you're away from your vehicle and simple quick access to your gear when you need it most. During on-duty use, you'll appreciate the timesavings of Tuffy's patented Pry-Guard II locking system. Our locking system secures the drawer shut while operating the vehicle without the need to lock and unlock the drawer every time access is needed.

Tuffy's superior design and engineering results in a secure drawer system that is typically lighter weight than others on the market. Tuffy's new vented enclosures are perfect for keeping today's sensitive electronics cool under pressure. As an added convenience, we can easily key all of your fleets units alike or upgrade them to a combination pushbutton lock, alleviating potential lost key issues all together.

Call 800.348.8339 for a free consultation and quote for your fleet.

Tuffy Security Product's Tactical Gear Security Drawers are the state of the art in secure gear storage and organization. These highly functional, highly secure, and fully customizable drawer units are precision crafted in the USA. Configurations are available for most foreign and domestic SUVs, trucks and sedans.



## TUFFY'S SELECTION OF STANDARD DRAWER SIZES

### Chevy Tahoe / Ford Expedition / Hummer H1

Part #167-470410160-000-01: Color - Black

Exterior Dimensions: 47"W x 41"L (Plus 1 1/4" for handle) x 16"H

Interior Dimensions: 44 3/4"W x 40 1/16"L x 13 1/4"H (Less 1 9/16" at center for striker)

### Chevy Tahoe / Ford Expedition with Prisoner/K9 Cage

Part #167-470350160-000-01: Color - Black

Exterior Dimensions: 47"W x 35"L (Plus 1 1/4" for handle) x 16"H

Interior Dimensions: 44 3/4"W x 34 1/16"L x 13 1/4"H (Less 1 9/16" at center for striker)

### 2014+ Dodge Durango / 2011+ Ford Explorer / 2013+ Ford Interceptor SUV

Part #167-400360160-000-01: Color - Black

Exterior Dimensions: 40"W x 36"L (Plus 1 1/4" for handle) x 16"H

Interior Dimensions: 37 3/4"W x 35 1/16"L x 13 1/4"H (Less 1 9/16" at center for striker)

### 1998-2013 Dodge Durango / 2006-2010 Ford Explorer / 2007-2012 GMC Acadia:

Part #167-450390160-000-01: Color - Black

Exterior Dimensions: 45"W x 39"L (Plus 1 1/4" for handle) x 16"H

Interior Dimensions: 42 3/4"W x 38 1/16"L x 13 1/4"H (Less 1 9/16" at center for striker)

### 2013+ Chevy Traverse / 2007+ Ford Edge

### 2013+ GMC Acadia / 2005+ Jeep Grand Cherokee

Part #167-400300160-000-01: Color - Black

Exterior Dimensions: 40"W x 30"L (Plus 1 1/4" for handle) x 16"H

Interior Dimensions: 37 3/4"W x 29 1/16"L x 13 1/4"H (Less 1 9/16" at center for striker)

### 2013+ Ford Escape / 2008+ Jeep Liberty

Part #167-400240160-000-01: Color - Black

Exterior Dimensions: 40"W x 24"L (Plus 1 1/4" for handle) x 16"H

Interior Dimensions: 37 3/4"W x 23 1/16"L x 13 1/4"H (Less 1 9/16" at center for striker)

### Ford Escape / 2012+ Hyundai Santa Fe

Part #167-400270120-000-01: Color - Black

Exterior Dimensions: 40"W x 27"L (Plus 1 1/4" for handle) x 12"H

Interior Dimensions: 37 3/4"W x 26 1/16"L x 9 1/4"H (Less 1 9/16" at center for striker)

### 2014+ Jeep Cherokee

Part #167-380230130-000-01: Color - Black

Exterior Dimensions: 38"W x 23"L (Plus 1 1/4" for handle) x 13"H

Interior Dimensions: 37 3/4"W x 22 1/16"L x 12 1/4"H (Less 1 9/16" at center for striker)

### 2013+ Chevy Equinox / 2013+ GMC Terrain

Part #167-360300120-000-01: Color - Black

Exterior Dimensions: 36"W x 30"L (Plus 1 1/4" for handle) x 12"H

Interior Dimensions: 35 3/4"W x 29 1/16"L x 11 1/4"H (Less 1 9/16" at center for striker)

### 2007+ Jeep Wrangler Unlimited

Part #167-340260140-000-01: Color - Black

Exterior Dimensions: 34"W x 26"L (Plus 1 1/4" for handle) x 14"H

Interior Dimensions: 33 3/4"W x 25 1/16"L x 13 1/4"H (Less 1 9/16" at center for striker)

### International CXT

Part #167-480140090-000-01: Color - Black

Exterior Dimensions: 48"W x 14"L (Plus 1 1/4" for handle) x 9"H

Interior Dimensions: 45 3/4"W x 13 3/16"L x 6 1/4"H (Less 1 9/16" at center for striker)

### Universal Extended Cab Pickup Truck

Part #167-120570140-000-01: Color - Black

Exterior Dimensions: 12"W x 57"L (Plus 1 1/4" for handle) x 14"H

Interior Dimensions: 9 3/4"W x 56 9/16"L x 11 1/4"H (Less 1 9/16" at center for striker)

### 2011-current Ford Interceptor Sedan / 2011+ Chevy Caprice / 1998-2011 Ford Crown Victoria

Part #167-420220080-000-01: Color - Black

Exterior Dimensions: 42" W x 22" L (Plus 1 1/4" for handle) x 8" H

Interior Dimensions: 39 3/4" W x 21 1/16" L x 5 3/8" H (Less 1 9/16" at center for striker)

**Mounting:** Mounts to the floor of the vehicle. Mounting kit may be required for specific vehicles, sold separately.



## READY TO SHIP & CUSTOMIZABLE:

Single drawers, side by side drawers and stacked drawers of varying sizes are all available configurations.

Alternate sizes are available. Standard material is steel, however any drawer can also be constructed from aluminum with steel slides.

Call 866.318.8339 for pricing and options.

Single Drawer Part# 167

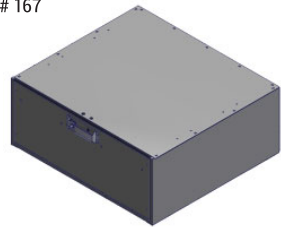

Side by Side Drawers Part # 171

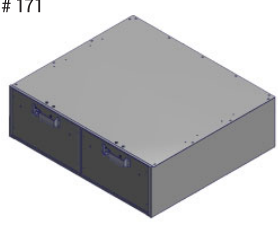

Over Under Drawers with Vented Electronics Enclosure Part# 330

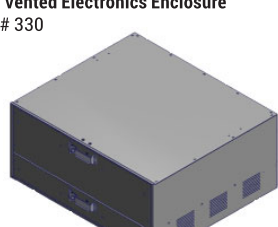

Over Under Drawers Part# 258

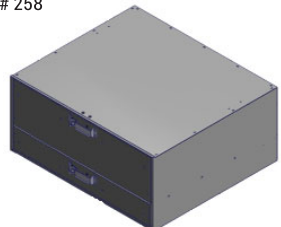

Side by Side Drawers with a Bottom Drawer Part # 329

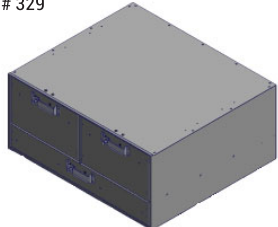

Side by Side Drawers with a Bottom Drawer and a Vented Electronics Enclosure Part # 328

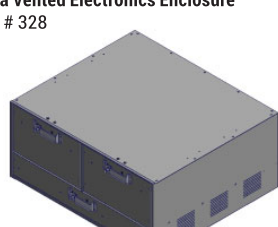

### Standard Manufacturing Features:

- Mounting holes prepunched on 1" centers
- Grade 8 mounting hardware provided
- Heavy duty drawer crossbrace
- Tab-loc welded construction
- Durable texture powder coat finish

Heavy duty reinforced 1/8" and 16 gauge thick welded top cross supports. Top is rated to 300# evenly distributed (side by side models are rated to 550# evenly distributed)

Heavy duty, space saving, bottom mount roller bearing slides feature (8) precision ground stainless steel sealed roller bearings mounted in an innovated 1/8" thick steel slide system pulls out 75% and rated to 250# evenly distributed on standard drawer

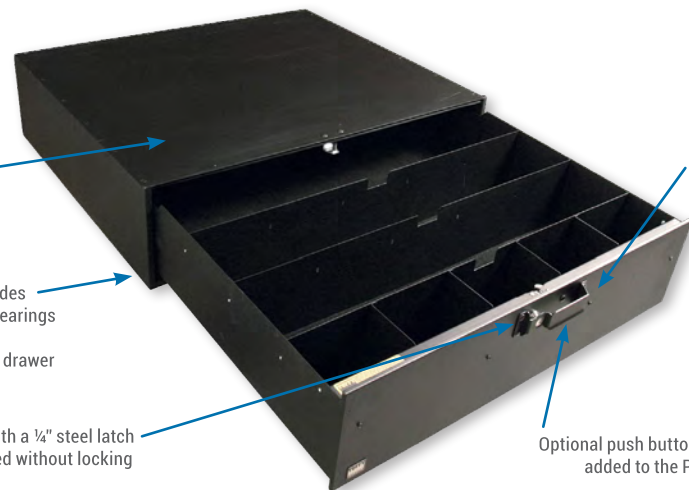

### Available but sold separately:

- Carpet kits for the top and inside
- Rubber mat for the top and inside
- Divider kits (shown installed)
- Custom weapons foam inserts

Patented Anti-twist push button lock system with a 10 tumbler double bitted security key containing built in weather seals and a large comfortable handle.

Typically lighter weight than others on the market through superior engineering



Patented Pry-Guard II locking system with a 1/2" steel latch which enables the lid to be latched closed without locking

Optional push button combination lock added to the Pry-Guard II system

### Mounting Kits

Don't settle for wood two by fours! The engineers at Tuffy design mounting brackets for every security drawer we manufacture. Designed to integrate with the existing vehicle's mounting points providing years of worry free stability. When upgrading your fleet to a comparable model, there's no need to get a new drawer, just upgrade your mounting kit! Made from 1/8" inch steel with grade 8 mounting hardware, our mounting kits are in stock for all standard models.



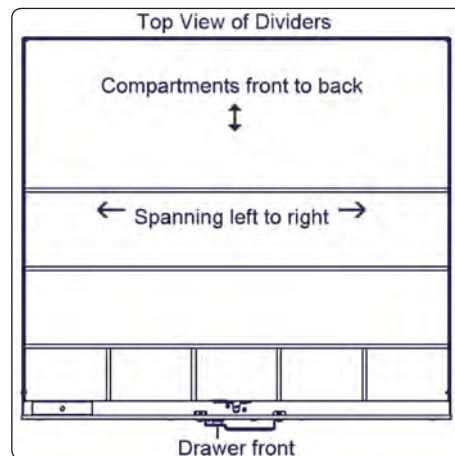

**Left to Right Dividers**

- Part #168, Single Drawer
- Part #172, Side by Side Drawers
- Part #259, Stacked Drawers

Divider mounting locations are adjustable on 1" centers and include large panels spanning left to right creating storage compartments front to back. Also includes smaller front partitions.

Standard configuration is shown in the image but alternate quantities of dividers are available.

Carpet finish sold separately.

**Mounting (if not pre-installed):**

Bolts into the drawer with the hardware supplied.

**Fits:**

- Part #168 Fits Tactical Gear Security Drawer #167: Single enclosure with a single drawer.
- Part #172 Fits Tactical Gear Security Drawer #171: Single enclosure with two side by side drawers.
- Part #259 Fits Tactical Gear Security Drawer #258: Single enclosure with two vertically stacked drawers.

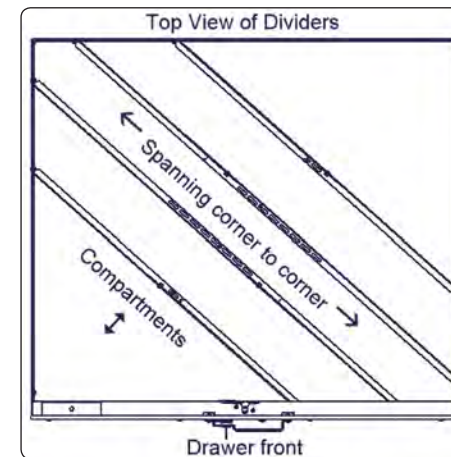

**Corner to Corner Dividers**

- Part #233, Single Drawer
- Part #261, Stacked Drawers

Divider mounting locations are adjustable on 1" centers and include large panels spanning corner to corner creating longer angled storage compartments. Ideal for long firearms. Mounts in 1 drawer configurations.

Standard configuration is shown in the image, but alternate quantities of dividers are available depending on the drawer size.

Carpet finish sold separately.

**Mounting (if not pre-installed):**

Bolts into the drawer with the hardware supplied.

**Fits:**

- Part #233 Fits Tactical Gear Security Drawer #167: Single enclosure with a single drawer
- Part #261 Fits Tactical Gear Security Drawer #258: Single enclosure with two vertically stacked drawers

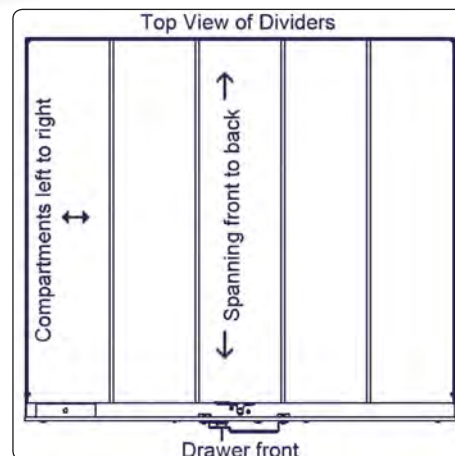

**Front to Back Dividers**

- Part #222, Single Drawer
- Part #228, Side by Side Drawers
- Part #260, Stacked Drawers

Divider mounting locations are adjustable on 1" centers and include large panels spanning from front to back creating storage compartments left to right. Standard configuration is shown in the image, but alternate quantities of dividers are available depending on drawer size.

Carpet finish sold separately.

**Mounting (if not pre-installed):**

Bolts into the drawer with hardware supplied.

**Fits:**

- Part #222 Fits Tactical Gear Security Drawer #167: Single enclosure with a single drawer.
- Part #228 Fits Tactical Gear Security Drawer #171: Single enclosure with two side by side drawers.
- Part #260 Fits Tactical Gear Security Drawer #258: Single enclosure with two vertically stacked drawers.

**Drawer Carpet Finish For Interior, Exterior & Dividers**

The drawer carpet finish features a durable stain resistant automotive grade carpet with powder coated metal trim where applicable.

The attractive exterior finish adds cushion and durability.

The drawer interior finish adds a layer of cushion to protect the drawer contents.

Dividers and drawers sold separately.

**Mounting (if not pre-installed):**

Affix finish material to the drawer interior using the provided adhesive and trim with a utility knife.

On interior and exterior trim kits the metal edge trim is fastened with the provided mounting hardware.

**Carpet Finish Kit Part Numbers:**

Drawer Exteriors	Dividers
Part #229 for #167	Part #231 for #168
Part #229 for #171	Part #241 for #172
Part #263 for #258	Part #232 for #222
	Part #232 for #228
<b>Drawer Interiors</b>	Part #234 for #233
Part #230 for #167	Part #265 for #259
Part #237 for #171	Part #266 for #260
Part #264 for #258	Part #267 for #261

**Carpet Finish Kit Available Colors:**

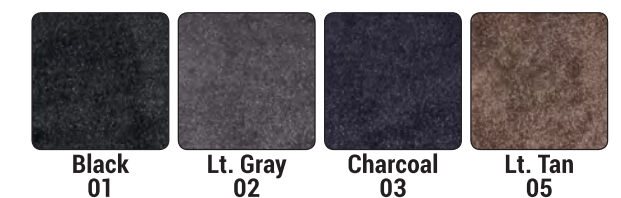

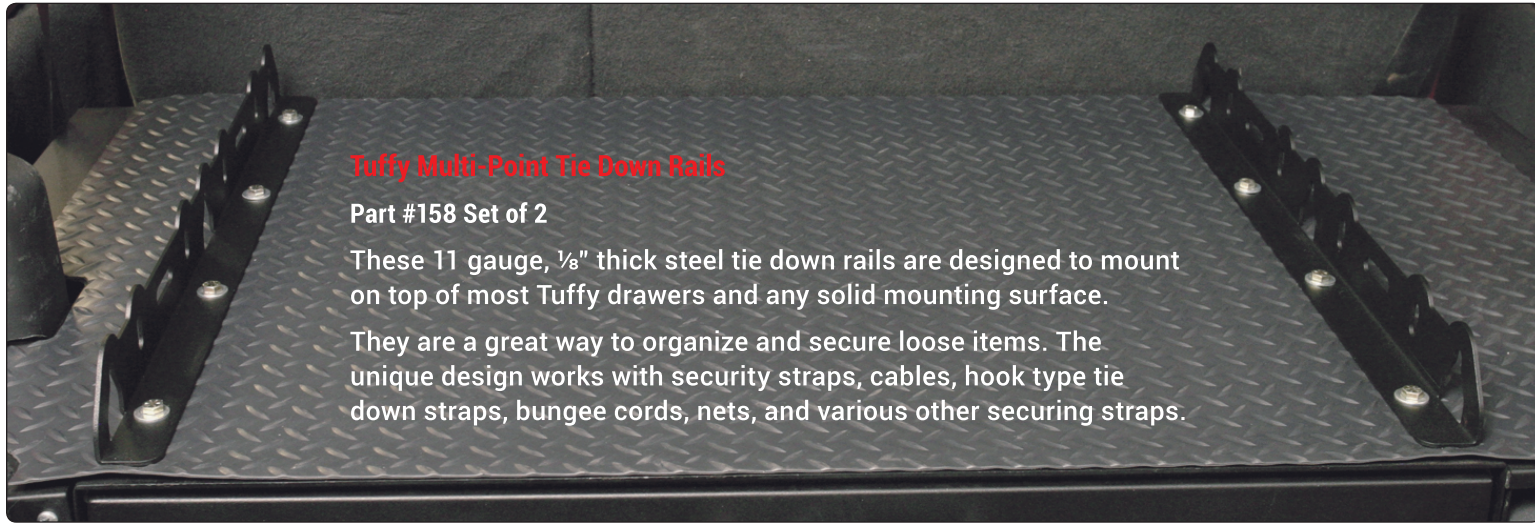

**Tuffy Multi-Point Tie Down Rails**

Part #158 Set of 2

These 11 gauge, 1/8" thick steel tie down rails are designed to mount on top of most Tuffy drawers and any solid mounting surface.

They are a great way to organize and secure loose items. The unique design works with security straps, cables, hook type tie down straps, bungee cords, nets, and various other securing straps.



**Tuffy Modular Gear Anchors**

Part #159 Set of 4

These 11 gauge, 1/8" thick steel gear anchors are designed to mount on top of most of Tuffy drawers and any solid mounting surface.

They are a great way to organize and secure loose items. The unique design works with security straps, cables, hook type tie down straps, bungee cords, nets, etc.

**Tuffy Anchor Rail**

Part #882

The Anchor rail is constructed from high strength aluminum and is available in a variety of lengths. The sleek design maintains a small non-obtrusive profile.

The anchor rail is strong enough to secure a variety of items. The anchor rings are easily positioned and extremely strong with an assembly break strength of 4000 lbs. and work load limit of 1,333 lbs.



**Super Security Storage Trunk**

Part #025

This high security 16 gauge steel storage trunk mounts behind a rear seat, a third row seat or any tight space requiring additional security for firearms, gear and valuables. Its universal shape makes it ideal for many mounting applications in a variety of spaces.

Tuffy's patented Anti-Twist push button lock system with a 10 tumbler double bitted security key containing built in weather seals coupled with Tuffy's patented Pry-Guard II locking system with two 1/4" steel latches, your weapons, gear and valuables will remain secure.

The Super Security Storage Trunk has 3,320 cubic inches of storage space and at 33 1/8" wide will accommodate a fully extended Colt M-4 Carbine.

It also comes with a large removable storage tray for smaller items, a durable powder coat finish and grade 8 mounting hardware.



# 2007+ CHEVY SILVERADO / GMC SIERRA CREW CAB UNDER REAR SEAT LOCKBOX



This high security 16 gauge steel security lockbox mounts under the rear seat in a Chevy Silverado Crew Cab. The full width formfitting design of the Tuffy lockbox has over 3500 cubic inches of lockable storage.

It's secured contents are easily accessed by flipping either or both of the rear seat(s) up and opening the corresponding lid(s). The unique design allows the full width to be used to stow firearms or other long items.

Featuring Tuffy's Pry-Guard Locking System with a 10 tumbler double bitted security lock with built in weather seals. Chamfered corners are incorporated into the design for easier passenger access.

The innovative mounting system is only accessed from inside the box. When additional floor space is needed the entire lockbox can be removed in seconds without the need for any tools.

Mounts inconspicuously under the seat out of apparent site of would be thieves. Is quickly and easily installed using the factory hardware without drilling.

This stealthy design has over 3500 cubic inches of lockable storage space that is hidden under the seat from prying eyes.

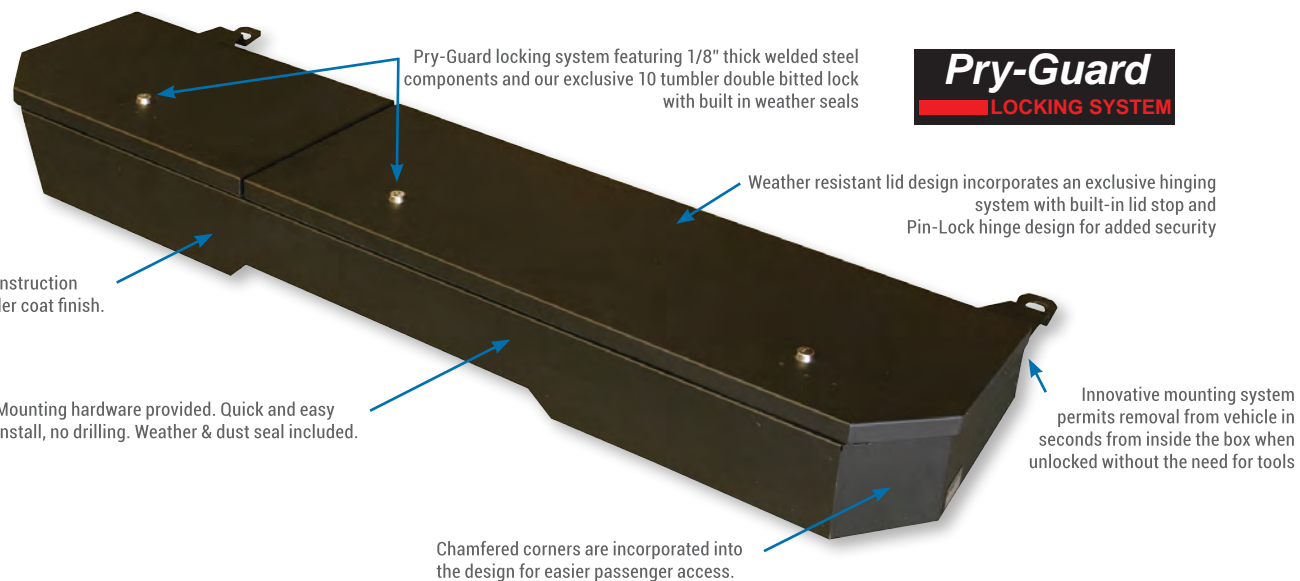

Pry-Guard locking system featuring 1/8" thick welded steel components and our exclusive 10 tumbler double bitted lock with built in weather seals

**Pry-Guard**  
LOCKING SYSTEM

Weather resistant lid design incorporates an exclusive hinging system with built-in lid stop and Pin-Lock hinge design for added security

Welded 16 Gauge steel construction with durable texture powder coat finish.

Mounting hardware provided. Quick and easy install, no drilling. Weather & dust seal included.

Innovative mounting system permits removal from vehicle in seconds from inside the box when unlocked without the need for tools

Chamfered corners are incorporated into the design for easier passenger access.



## Fits:

Chevy Silverado Crew Cab 2007 - Current  
GMC Sierra Crew Cabs (All chassis) 2007 - Current  
*(Fits Crew Cab only and does not fit Double and Regular Cab)*

## Mounting:

No Drilling required. Fastens with original OEM hardware.

## Optional Accessories:

Pick N Pluck Foam | 082 3-Digit Combination Camlock

## Specifications:

Part #: 307

Color: Black - 01

Exterior Dimensions Overall: 13" L x 55 7/8" W x 7"-5" H

*(Height is tapered front to back)*

Interior Dimensions: 12 3/8" L x 55 1/4" W x 5 1/2" - 3 5/8" H

*(Height is tapered front to back)*

Lid Opening: 11" L x 35 1/8" (with Large lid) & 19 1/8" (with Smaller lid)

Shipping Weight: 51 lbs.

# 2015+ FORD F150 SUPERCREW CREW CAB UNDER REAR SEAT LOCKBOX



This high security 16 gauge steel security lockbox mounts under the rear seat in a 2015+ Ford F150 SuperCrew Crew Cab. The full width formfitting design of the Tuffy lockbox has over 4500 cubic inches of lockable storage. It's secured contents are easily accessed by flipping either or both of the rear seat(s) up and opening the corresponding lid(s). The unique design allows the full width to be used to stow firearms or other long items.

Featuring Tuffy's Pry-Guard Locking System with a 10 tumbler double bitted security lock with built in weather seals. Chamfered corners are incorporated into the design making it easier to operate the seat releases as well as aiding passenger ingress and egress.

The innovative mounting system is only accessed from inside the box. When additional floor space is needed the entire lockbox can be removed in seconds without the need for any tools. Mounts inconspicuously under the seat out of apparent site of would be thieves. Is quickly and easily installed using the factory hardware without drilling.

This stealthy design has over 4500 cubic inches of lockable storage space that is hidden under the seat from prying eyes.

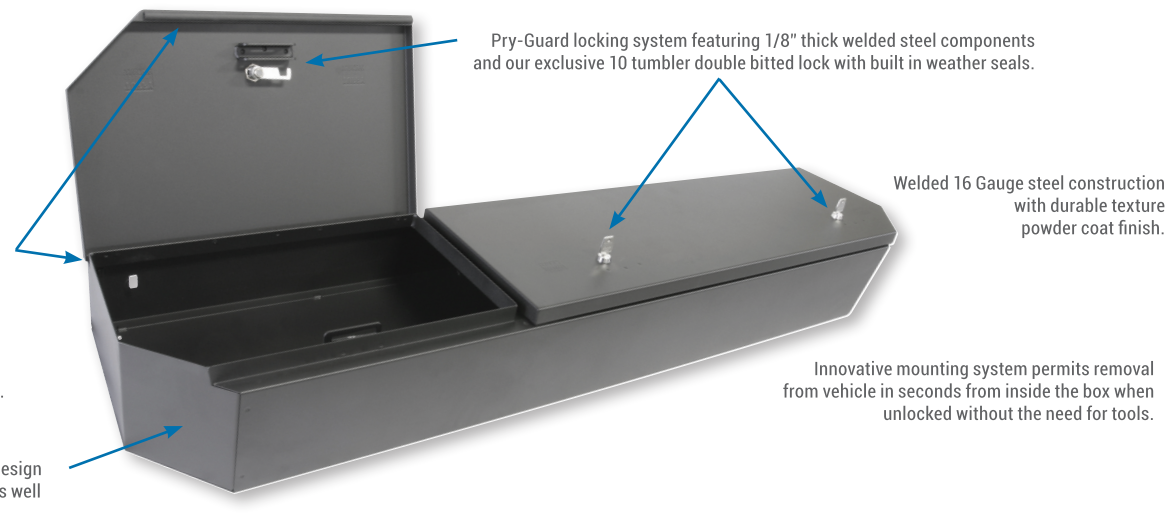

Pry-Guard locking system featuring 1/8" thick welded steel components and our exclusive 10 tumbler double bitted lock with built in weather seals.

Welded 16 Gauge steel construction with durable texture powder coat finish.

Weather resistant lid design incorporates an exclusive Pin-Lock hinging system with built-in lid stop for added security.

Mounting hardware provided. Quick and easy install, no drilling. Weather & dust seal included.

Chamfered corners are incorporated into the design making it easier to operate the seat releases as well as aiding passenger access.

**Pry-Guard**  
LOCKING SYSTEM



## Fits:

2015+ Ford F150 SuperCrew Crew Cab  
*(will NOT fit with under seat Sony subwoofer option)*  
2017+ Ford F250, F350 & F450 SuperCrew Crew Cab  
*(will NOT fit with under seat pop-up storage box)*

## Mounting:

No Drilling required. Fastens with original OEM hardware.

## Optional Accessories:

Pick N Pluck Foam | 082 3-Digit Combination Camlock

## Specifications:

Part #: 316

Color: Black - 01

Exterior Dimensions Overall: 56" w x 13" d x 8" h (front) - 6" h (back)

Interior Dimensions: 55 1/8" w x 12 1/8" d x 7 1/8" h (front) - 5 3/4" h (back)

Lid Opening: 36 1/2" x 10 1/8" (Large lid) & 18 3/8" x 10 1/8" (Smaller lid)

Shipping Weight: 54 lbs.

# 2009-2014 FORD F150/RAPTOR SUPER CREW & SUPER CAB UNDER REAR SEAT LOCK BOXES

# 2003-2016 FORD F250, F350 & F450 SUPER DUTY CREW CAB UNDER REAR SEAT LOCKBOX



Part #283 - Super Crew Full Width Under Rear Seat Lockbox without Subwoofer



Part #285 - Super Cab Under Rear Seat Lockbox



Part #287 - Supercrew Cab Full Width Under Rear Seat Lockbox with Subwoofer

This high security 16 gauge steel lockbox mounts under the rear seat in an F-150 SuperCrew or SuperCab with or without the subwoofer. The formfitting design of the Tuffy lockbox has over 2000 cubic inches of lockable storage.

It's secured contents are easily accessed by flipping the rear seat up. The innovative mounting system, only accessed from inside the box when unlocked, allows the entire lockbox to be removed in seconds without the need for any tools when extra floor space is needed or to store the lockbox and locked contents in an alternate location.

Featuring Tuffy's Pry-Guard Locking System with a 10 tumbler double bitted security lock with built in weather seals. Mounts inconspicuously under the seat out of apparent site of would be thieves. Quickly and easily installed using the factory hardware without drilling.



This high security 16 gauge steel security lockbox mounts under the rear seat in a Ford F-250 and F-350 Crew Cab. The full width formfitting design of the Tuffy lockbox has over 2170 cubic inches of lockable storage.

It's secured contents are easily accessed by flipping either or both of the rear seat(s) up and opening the corresponding lid(s). The unique design allows the full width to be used to stow firearms or other long items. Featuring Tuffy's Pry-Guard Locking System with a 10 tumbler double bitted security lock with built in weather seals. Chamfered corners are incorporated into the design for easier passenger access.

The innovative mounting system is only accessed from inside the box. Mounts inconspicuously under the seat out of apparent site of would be thieves.

This Super Duty Lock Box is quickly and easily installed using the factory hardware without drilling.

**Pry-Guard**  
LOCKING SYSTEM

**Pry-Guard**  
LOCKING SYSTEM



Welded 16 Gauge steel construction with durable texture powder coat finish.

Pry-Guard locking system featuring 1/8" thick welded steel components and our exclusive 10 tumbler double bitted lock with built in weather seals.

Weather resistant lid design incorporates an exclusive hinging system with built-in lid stop and Pin-Lock hinge design for added security.

Innovative mounting system permits removal from vehicle in seconds from inside the box when unlocked without the need for tools.

Mounting hardware provided. Quick and easy install, no drilling. Weather & dust seal included.

This stealthy design has over 2170 cubic inches of lockable storage space that is hidden under the seat from prying eyes.

For security a structural brace is welded to the box at the lid split

Welded 16 Gauge steel construction with durable texture powder coat finish.

Mounting hardware provided. Quick and easy install, no drilling. Weather & dust seal included.

Chamfered corners are incorporated into the design for easier passenger access.



## Specifications:

**Part #:** 283  
**Color:** Black-01  
**Capacity:** Over 4,000 in<sup>3</sup> of lockable storage space.  
**Exterior Dimensions Overall:** 14" L, 56" W, 7 3/8" H (Length and Height are tapered smaller)  
**Interior Dimensions:** 13 3/4" L, 55 3/8" W, 6 7/8" H (Length and Height are tapered smaller)  
**Lid Opening:** 11 7/8" L, 36 1/8" W (Large lid) & 18 1/8" W (Small lid)

## Fits:

Ford F150 Super Crew 2009-2014; Raptor Super Crew, without subwoofer or with subwoofer removed.

## Mounting:

No Drilling required. Fastens with original OEM hardware.

## Specifications:

**Part #:** 285  
**Color:** Black-01  
**Capacity:** Over 2,075 in<sup>3</sup> of lockable storage space.  
**Exterior Dimensions Overall:** 11 1/4" L, 31 7/8" W, 7" H (Height is tapered smaller)  
**Interior Dimensions:** 11 1/8" L, 31 3/8" W, 6 9/16" H (Height is tapered smaller)  
**Lid Opening:** 9 3/16" L, 31 3/8" W

## Fits:

Ford F150 Extended Cab 2009-2014. Raptor Extended Cab, with or without subwoofer (Mounts under drivers side rear seat only)

## Mounting:

No Drilling required. Fastens with original OEM hardware.

## Specifications:

**Part #:** 287  
**Color:** Black-01  
**Capacity:** Over 2,740 in<sup>3</sup> of lockable storage space.  
**Exterior Dimensions Overall:** 14" L, 38 1/2" W, 7 3/8" H (Length and Height are tapered smaller)  
**Interior Dimensions:** 13 3/4" L, 38" W, 6 7/8" H (Length and Height are tapered smaller)  
**Lid Opening:** 11 7/8" L, 36 1/8" W

## Fits:

Ford F150 Super Crew 2009-2014. Raptor Super Crew 2011+, with or without subwoofer (Mounts under drivers side rear seat only)

## Mounting:

No Drilling required. Fastens with original OEM hardware.

## Fits:

Ford F250, F350 & F450 Crew Cab (4-door) 2003 - 2016 Requires removal of factory under-seat trays/boxes (Fits Crew Cab only and does not fit Super and Regular Cab)

## Mounting:

No Drilling required. Fastens with original OEM hardware.

## Optional Accessories:

Pick N Pluck Foam | 082 3-Digit Combination Camlock

## Specifications:

**Part #:** 309  
**Color:** Black - 01  
**Exterior Dimensions Overall:** 58 1/16" x 11 1/4" x 6" - 3 7/8" (tapered front to back)  
**Interior Dimensions:** 57 3/16" x 11 1/8" x 5 3/8" - 3 5/8" (tapered front to back)  
**Lid Opening:** 37 3/4" x 9 1/4" (Large lid) & 18 5/8" x 9 1/4" (Smaller lid)  
**Shipping Weight:** 45 lbs.

# 2009+ RAM 1500, 2500 & 3500 CREWCAB AND QUADCAB STORAGE SECURITY LIDS

## 2009-2015 RAM In-Floor Storage Security Lid

Works in the crew cab and quad cab. **Does not work in the mega cab.**

This heavy duty locking In-floor Storage Security Lid replaces the existing plastic cover from the factory. Constructed from 16 gauge and 1/8" thick welded steel. It creates secure storage in the hidden floor compartment which is ideal for securing valuable tools and gear. The unique design features our Pry-Guard locking system with 1/8" thick steel components and a welded continuous steel hinge. The lid also provides a sturdier and more durable deck surface for items placed on top. Easy to install using standard hand tools in just a few minutes.

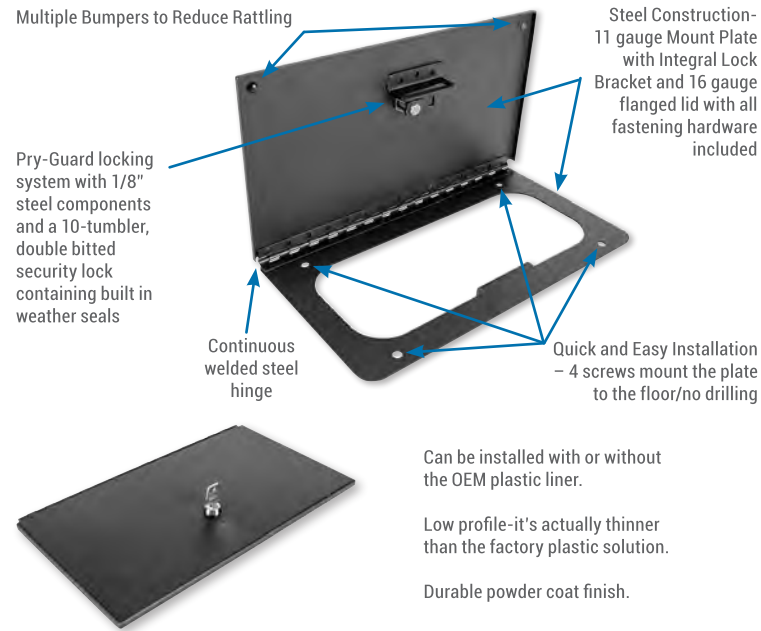

### Specifications:

**Part #:** 311  
**Color:** Black - 01  
**Exterior Dimensions Overall:** Approximately the same size as OEM cover  
**Interior Dimensions:** Secures over 500 in<sup>3</sup> of volume in storage area.  
**Shipping Weight:** 7 lbs.

### FITS:

2009 - 2015 RAM 1500, 2500 & 3500 Crewcab and Quadcab.  
**Does not fit the RAM Megacab.**

### Mounting

No drilling required, mounts to original factory holes.

## 2009-2015 RAM Underseat Storage Security Lid

Works in the crew cab and quad cab. **Does not work in the mega cab.**

This heavy duty locking Under Seat Storage Security Lid replaces the existing plastic OEM folding platform from the factory. Constructed from 16 gauge and 1/8" thick welded steel. It creates secure storage in the hidden seat compartment which is ideal for securing valuable tools and gear. The unique design features our Pry-Guard locking system with 1/8" thick steel components and a welded continuous steel hinge. The lid also provides a sturdier and more durable deck surface for items placed on top. Easy to install using standard hand tools in just a few minutes.

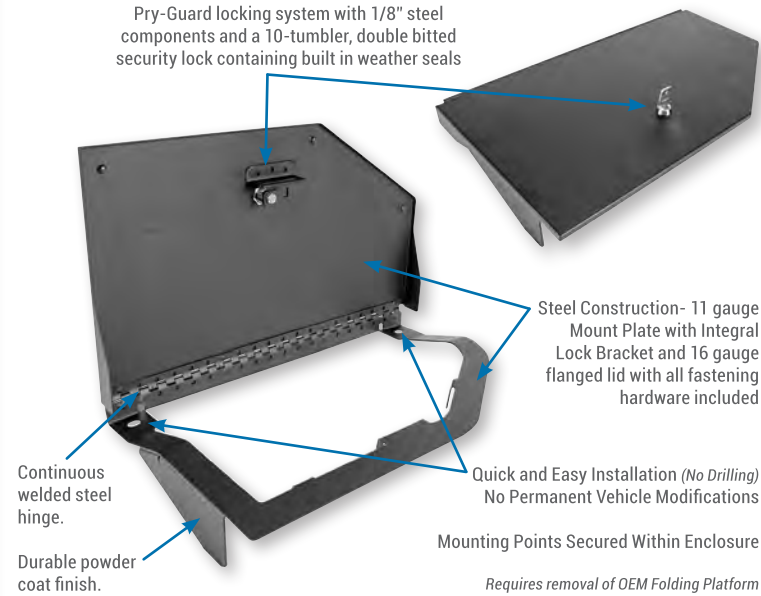

### Specifications:

**Part #:** 312  
**Color:** Black - 01  
**Exterior Dimensions Overall:** 21" x 13 7/8" x 3 1/4"  
**Interior Dimensions:** Secures over 600 in<sup>3</sup> of volume in storage area.  
**Shipping Weight:** 11 lbs.

### FITS:

2009 - 2015 RAM 1500, 2500 & 3500 Crewcab and Quadcab.  
**Does not fit the RAM Megacab.**

### Mounting

No drilling required, mounts to original factory holes.

# 2007-2014 TOYOTA TUNDRA DOUBLECAB UNDER REAR SEAT LOCKBOX



This high security 16 gauge steel security lockbox mounts under the rear seat in a Toyota Tundra DoubleCab. The full width formfitting design of the Tuffy lockbox has over 3200 cubic inches of lockable storage.

Its secured contents are easily accessed by flipping either or both of the rear seat(s) up and opening the corresponding lid(s). The unique design allows the full width to be used to stow firearms or other long items.

Featuring Tuffy's Pry-Guard Locking System with a 10 tumbler double bitted security lock with built in weather seals. Chamfered corners are incorporated into the design making it easier to operate the seat releases as well as aiding passenger ingress and egress.

The innovative mounting system is only accessed from inside the box. When additional floor space is needed the entire lockbox can be removed in seconds without the need for any tools.

Mounts inconspicuously under the seat out of apparent site of would be thieves. Is quickly and easily installed using the factory hardware without drilling.

This stealthy design has over 3200 cubic inches of lockable storage space that is hidden under the seat from prying eyes.

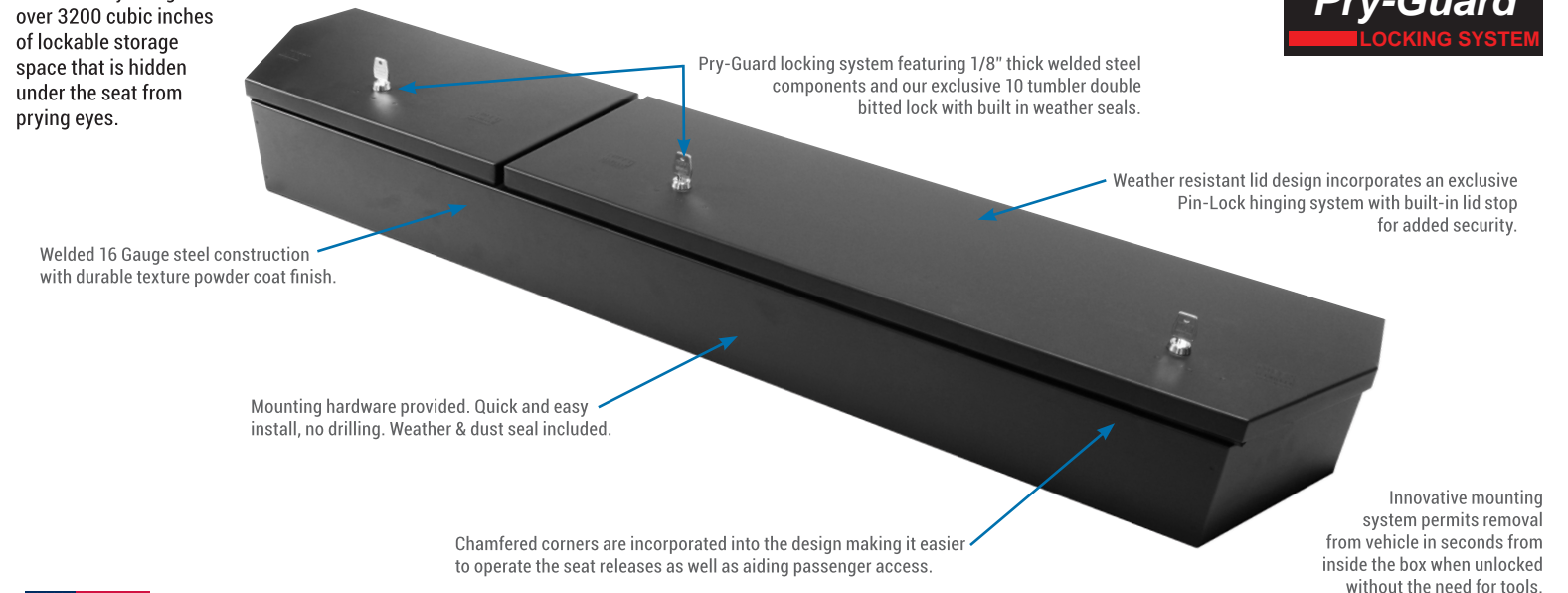

**Pry-Guard**  
 LOCKING SYSTEM



### Fits:

Toyota Tundra DoubleCab 2007-2014  
*(Fits Double Cab only and does not fit CrewMax or Regular Cabs)*

### Mounting:

No Drilling required. Fastens with original OEM hardware.

### Optional Accessories:

Pick N Pluck Foam | 082 3-Digit Combination Camlock

### Specifications:

**Part #:** 313  
**Color:** Black - 01  
**Exterior Dimensions Overall:** 55 3/8" x 12" x 6 1/4" - 5" (tapered front to back)  
**Interior Dimensions:** 54 1/8" x 11 1/8" x 5 1/8" - 4 3/4" (tapered front to back)  
**Lid Opening:** 31 3/4" x 10" (Large lid) & 18 5/8" x 10" (Smaller lid)  
**Shipping Weight:** 47 lbs.



# 2004-CURRENT CHEVY SILVERADO/GMC SIERRA SECURITY CONSOLE INSERT

# 2015-CURRENT FORD F150 SECURITY CONSOLE INSERT



Continuing the Tuffy legacy of designing and manufacturing the finest console inserts in the industry since 1997, Tuffy is proud to introduce our new line-up of console inserts for both the Chevy Silverado and GMC Sierra trucks with a flow-thru console.

This 16 gauge steel console insert provides style, security and convenience. While maintaining the refined curves of the OEM console, the Tuffy console insert transforms your OEM console into a heavy-duty lockable storage area utilizing Tuffy's Pry-Guard locking system with 10 tumbler double bitted security key to help protect valuables from thieves. The Tuffy console insert provides access to optional OEM USB and power outlets from the console. The innovative design utilizes an exclusive lid support feature that keeps the lid open while accessing contents.

The insert maintains a completely stock look including full use of armrest and lid. Featuring a durable texture powder coat finish, the insert comes ready to install in just a few minutes without drilling.

Patent rights reserved.



**GREAT FOR FLEETS AND PERSONAL USE!**

Tuffy exclusive lid support feature that keeps the lid open while accessing contents.

Integrated form fitting design provides access to OEM USB and power outlets from the console.

Quick and easy install, no drilling.



Maintains full use of the factory accessory tray, armrest and lid.

Exclusive 10 tumbler double bitted lock with built in weather seals.

Featuring Pry-Guard locking system with 1/8" thick welded steel components

Welded 16 Gauge steel construction . Durable texture powder coat finish.



Continuing the Tuffy legacy of designing and manufacturing the finest console inserts in the industry since 1997, Tuffy is proud to introduce our new line-up of console inserts for full size trucks beginning with the Ford F-150 flow-through center console insert.

This 16 gauge steel console insert provides style, security and convenience. While maintaining the refined curves of the OEM console, the Tuffy console insert transforms your console into a heavy-duty lockable storage area utilizing Tuffy's Pry-Guard locking system with 10 tumbler double bitted security key to help protect valuables from thieves.

The Tuffy console insert provides access to optional OEM USB and power outlets inside the console utilizing an exclusive lid support feature that keeps the lid open while accessing contents. It maintains a completely stock look including full use of the OEM accessory tray, armrest and lid. Featuring a durable texture powder coat finish, the insert comes ready to install in just a few minutes without drilling.

Patent rights reserved.



**GREAT FOR FLEETS AND PERSONAL USE!**



Tuffy exclusive lid support feature that keeps the lid open while accessing contents.

Integrated form fitting design. Quick and easy install, no drilling.

Featuring Pry-Guard locking system with 1/8" thick welded steel components

Maintains full use of the factory accessory tray, armrest and lid.

Exclusive 10 tumbler double bitted lock with built in weather seals.

Welded 16 Gauge steel construction . Durable texture powder coat finish.

## Fits:

2014-Current Chevy Silverado/GMC Sierra w/Flow-thru Console  
(Requires removal of forward bin, and hanging folder supports.)

## Mounting:

Installs in just a few minutes with hand tools, no drilling.

## Optional Accessories:

870: Auto On/Off LED Light  
082: 3-Digit Combination Camlock

## Specifications:

Part #: 320  
Color: Black - 01  
Exterior Dimensions Overall: 8.950" L x 12.878" W x 8.723"H  
(9.511" H with finger pull)  
Interior Dimensions: Over 950 cubic inches.  
Shipping Weight: 9 lbs.  
OEM console not included.



## Fits:

2015-Current Ford F150 flow-through center console

## Mounting:

Installs in just a few minutes with hand tools, no drilling.

## Optional Accessories:

870: Auto On/Off LED Light  
082: 3-Digit Combination Camlock

## Specifications:

Part #: 317  
Color: Black - 01  
Exterior Dimensions Overall: 14 1/2" x 11 5/8" x 8 1/2"  
Interior Dimensions: Over 1,430 cubic inches.  
Shipping Weight: 9 lbs.  
OEM console not included.



# 2009-2014 FORD F150 SECURITY CONSOLE INSERT

Continuing the Tuffy legacy of designing and manufacturing the finest console inserts in the industry since 1997, Tuffy is proud to introduce our new line-up of console inserts for full size trucks beginning with the Ford F-150 flow-through center console insert.

This 16 gauge steel console insert provides style, security and convenience. While maintaining the refined curves of the OEM console, the Tuffy console insert transforms your console into a heavy-duty lockable storage area utilizing Tuffy's Pry-Guard locking system with 10 tumbler double bitted security key to help protect valuables from thieves. The Tuffy console insert provides access to optional OEM USB and power outlets inside the console utilizing an exclusive lid support feature that keeps the lid open while accessing contents. It maintains a completely stock look including full use of the OEM accessory tray, armrest and lid. Featuring a durable texture powder coat finish, the insert comes ready to install in just a few minutes without drilling. **Patent rights reserved.**



**GREAT FOR FLEETS  
AND PERSONAL USE!**

Tuffy exclusive lid support feature that keeps the lid open while accessing contents.

Provides access to optional OEM USB and power outlets inside the console.

Featuring Pry-Guard locking system with 1/8" thick welded steel components

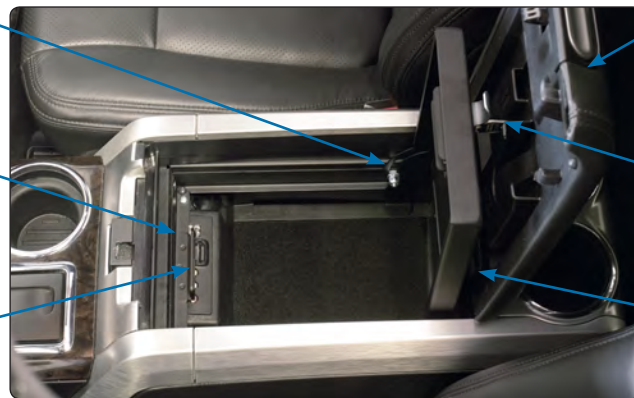

Maintains full use of the factory accessory tray, armrest and lid.

Exclusive 10 tumbler double bitted lock with built in weather seals.

Quick and easy install, no drilling  
Welded 16 Gauge steel construction  
Durable texture powder coat finish

**Pry-Guard**  
LOCKING SYSTEM



## Fits:

2009-2014 Ford F150 flow-through center console

## Mounting:

Installs in just a few minutes with hand tools, no drilling.

## Optional Accessories:

870: Auto On/Off LED Light  
082: 3-Digit Combination CamLock

## Specifications:

Part #: 315  
Color: Black - 01  
Exterior Dimensions Overall: 12 1/8" x 12" x 8 1/2"  
Interior Dimensions: Over 1,050 cubic inches.  
Shipping Weight: 9 lbs.  
*OEM console not included.*

# 2011-2016 FORD SUPER DUTY F250, F350, F450 & 550 SECURITY CONSOLE INSERT

Continuing the Tuffy legacy of designing and manufacturing the finest console inserts in the industry since 1997, Tuffy is proud to introduce our new security console insert for the Ford Super Duty 2011-2016 with a flow-through center console.

This 16 gauge steel console insert provides style, security and convenience. While maintaining the refined curves of the OEM console, the Tuffy console insert transforms your OEM console into a heavy-duty lockable storage area utilizing Tuffy's Pry-Guard locking system with 10 tumbler double bitted security key to help protect valuables from thieves.

The Tuffy console insert provides access to optional OEM power outlets in the console. The innovative design utilizes an exclusive lid support feature that keeps the lid open while accessing contents.

The insert maintains a completely stock look including full use of the factory accessory rubber insert, armrest and lid. Featuring a durable texture powder coat finish, the insert comes ready to install in just a few minutes without drilling. **Patent rights reserved.**



**GREAT FOR FLEETS  
AND PERSONAL USE!**

Tuffy exclusive lid support feature that keeps the lid open while accessing contents.

Includes external integrated accessory tray to keep convenience items within easy reach.

Provides cord access to optional OEM 12v power outlets from the console.

Quick and easy install, no drilling.

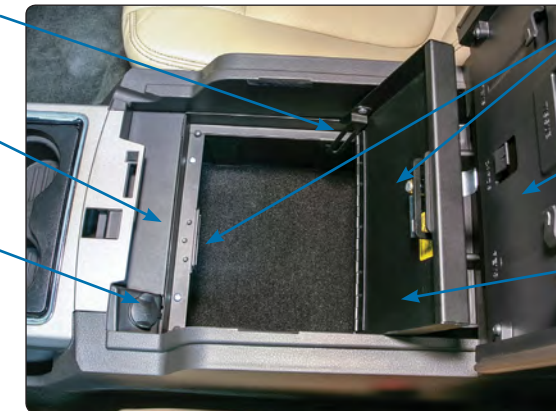

Featuring Pry-Guard locking system with 1/8" thick welded steel components. Exclusive 10 tumbler double bitted lock with built in weather seals.

Maintains full use of the factory accessory rubber insert, armrest and lid.

Welded 16 Gauge steel construction and durable texture powder coat finish.

**Pry-Guard**  
LOCKING SYSTEM



## Fits:

2011-2016 Ford Super Duty F250, F350, F450 & F550 with a flow-through center console.

## Mounting:

Installs in just a few minutes with hand tools, no drilling.

## Optional Accessories:

870: Auto On/Off LED Light  
082: 3-Digit Combination CamLock

## Specifications:

Part #: 322  
Color: Black - 01  
Exterior Dimensions Overall: 16.280" L x 11.145" W x 8.793" H  
Interior Dimensions: Over 1,400 cubic inches.  
Shipping Weight: 9 lbs.  
*OEM console not included.*

# 2010-CURRENT RAM TRUCKS SECURITY CONSOLE INSERT

Continuing the Tuffy legacy of designing and manufacturing the finest console inserts in the industry since 1997, Tuffy is proud to introduce our new line-up of security console inserts for 2010-Current RAM Trucks with a fixed floor OEM console.

This 16 gauge steel console insert provides style, security and convenience. While maintaining the refined curves of the OEM console, the Tuffy console insert transforms your console into a heavy-duty lockable storage area utilizing Tuffy's Pry-Guard locking system with 10 tumbler double bitted security key to help protect valuables from thieves. The Tuffy console insert provides access to optional OEM USB and power outlets inside the console utilizing an exclusive lid support feature that keeps the lid open while accessing contents. It maintains a completely stock look including full use of the OEM accessory tray, armrest and lid. Featuring a durable texture powder coat finish, the insert comes ready to install in just a few minutes without drilling. **Patent rights reserved.**



**GREAT FOR FLEETS AND PERSONAL USE!**



Tuffy exclusive lid support feature that keeps the lid open while accessing contents.

Welded 16 Gauge steel construction. Durable texture powder coat finish.

Drilling required for secure installation.

Does not work with installed OEM remote CD players.

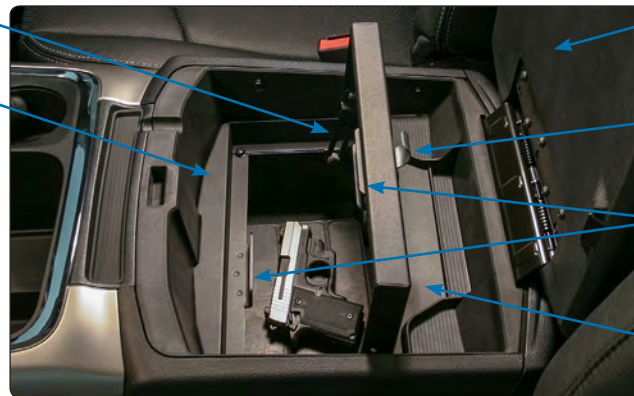

Maintains full use of the factory armrest and lid.

Exclusive 10 tumbler double bitted lock with built in weather seals and convenient finger pull.

Featuring Pry-Guard locking system with 1/8" thick welded steel components

Includes external integrated accessory tray to keep convenience items within easy reach.

**Pry-Guard**  
LOCKING SYSTEM



## Fits:

2010-Current RAM 1500, 2500 & 3500 Trucks with a fixed floor OEM console. (Does not work with the installed OEM remote CD player.)

## Mounting:

Simple install. Drilling required for secure installation.

## Optional Accessories:

870: Auto On/Off LED Light  
082: 3-Digit Combination Camlock

## Specifications:

Part #: 321  
Color: Black - 01  
Exterior Dimensions Overall: 9.054" L x 12.200" W x 5.481" H  
(6.270" H with finger pull)  
Interior Dimensions: Over 440 cubic inches.  
Shipping Weight: 9 lbs.  
OEM console not included.

# 2016-CURRENT TOYOTA TACOMA SECURITY CONSOLE INSERT

Continuing the Tuffy legacy of designing and manufacturing the finest security console inserts in the industry since 1997, Tuffy is proud to introduce our security console insert for the 2016+ Toyota Tacoma with a fixed center console.

This 16 gauge steel console insert provides style, security and convenience. While maintaining the refined curves of the OEM console, the Tuffy console insert transforms your OEM console into a heavy-duty lockable storage area utilizing Tuffy's Pry-Guard locking system with 10 tumbler double bitted security key to help protect valuables from thieves. The innovative design utilizes an exclusive lid support feature that keeps the lid open while accessing contents. The insert maintains a completely stock look including full use of armrest and lid.

Featuring a durable texture powder coat finish, the insert comes ready to install in just a few minutes without drilling. **Patent pending.**



**GREAT FOR FLEETS AND PERSONAL USE!**



Tuffy exclusive lid support feature that keeps the lid open while accessing contents.

Welded 16 Gauge steel construction. Durable texture powder coat finish.

Quick and easy install, no drilling.



Maintains full use of the factory armrest and lid.

Exclusive 10 tumbler double bitted lock with built in weather seals and convenient finger pull.

Featuring Pry-Guard locking system with 1/8" thick welded steel components

**Pry-Guard**  
LOCKING SYSTEM



## Fits:

2016-Current Toyota Tacoma with a fixed center console.

## Mounting:

Quick and easy install, no drilling.

## Optional Accessories:

870: Auto On/Off LED Light  
082: 3-Digit Combination Camlock

## Specifications:

Part #: 324  
Color: Black - 01  
Exterior Dimensions Overall: 7.505" L x 7.720" W x 7.288" H  
Interior Dimensions: Over 330 cubic inches.  
Shipping Weight: 9 lbs.  
OEM console not included.

# 2005-2015 TOYOTA TACOMA SECURITY CONSOLE INSERT

Continuing the Tuffy legacy of designing and manufacturing the finest security console inserts in the industry since 1997, Tuffy is proud to introduce our security console insert for the 2005-2015 Toyota Tacoma with a fixed center console.

This 16 gauge steel console insert provides style, security and convenience. While maintaining the refined curves of the OEM console, the Tuffy console insert transforms your OEM console into a heavy-duty lockable storage area utilizing Tuffy's Pry-Guard locking system with 10 tumbler double bitted security key to help protect valuables from thieves. The innovative design utilizes an exclusive lid support feature that keeps the lid open while accessing contents. The insert maintains a completely stock look including full use of armrest and lid. Featuring a durable texture powder coat finish, the insert comes ready to install in just a few minutes without drilling.

Patent pending.



**GREAT FOR FLEETS AND PERSONAL USE!**

# 2014-CURRENT TOYOTA TUNDRA SECURITY CONSOLE INSERT

Continuing the Tuffy legacy of designing and manufacturing the finest security console inserts in the industry since 1997, Tuffy is proud to introduce our security console insert for the 2014-Current Toyota Tundra with a fixed center console.

This 16 gauge steel console insert provides style, security and convenience. While maintaining the refined curves of the OEM console, the Tuffy console insert transforms your OEM console into a heavy-duty lockable storage area utilizing Tuffy's Pry-Guard locking system with 10 tumbler double bitted security key to help protect valuables from thieves. The Tuffy console insert provides access to optional OEM 12v power outlets from the console. The innovative design utilizes an exclusive lid support feature that keeps the lid open while accessing contents.

The insert maintains a completely stock look including full use of armrest and lid. Featuring a durable texture powder coat finish, the insert comes ready to install in just a few minutes without drilling.

Patent rights reserved.



**GREAT FOR FLEETS AND PERSONAL USE!**



Tuffy exclusive lid support feature that keeps the lid open while accessing contents.

Welded 16 Gauge steel construction. Durable texture powder coat finish.

Quick and easy install, no drilling.



Maintains full use of the factory armrest and lid.

Exclusive 10 tumbler double bitted lock with built in weather seals and convenient finger pull.

Featuring Pry-Guard locking system with 1/8" thick welded steel components

Tuffy exclusive lid support feature that keeps the lid open while accessing contents.

Includes external integrated accessory tray to keep convenience items within easy reach.

Provides cord access to OEM 12v power outlets.

Quick and easy install, no drilling.



Maintains full use of the factory armrest and lid.

Exclusive 10 tumbler double bitted lock with built in weather seals and convenient finger pull.

Featuring Pry-Guard locking system with 1/8" thick welded steel components

Welded 16 Gauge steel construction. Durable texture powder coat finish.

## Fits:

2005-2015 Toyota Tacoma with a fixed center console.

## Mounting:

Quick and easy install, no drilling.

## Optional Accessories:

- 870: Auto On/Off LED Light
- 082: 3-Digit Combination Camlock

## Specifications:

- Part #: 314
- Color: Black - 01
- Exterior Dimensions Overall: 7.901" L x 10.421"W x 6.75"H
- Interior Dimensions: Over 340 cubic inches.
- Shipping Weight: 9 lbs.
- OEM console not included.



## Fits:

2014-Current Toyota Tundra with a fixed center console.

## Mounting:

Installs in just a few minutes with hand tools, no drilling.

## Optional Accessories:

- 870: Auto On/Off LED Light
- 082: 3-Digit Combination Camlock

## Specifications:

- Part #: 323
- Color: Black - 01
- Exterior Dimensions Overall: 10.475" L x 11.434" W x 7.0" H (7.789" H with finger pull)
- Interior Dimensions: Over 900 cubic inches.
- Shipping Weight: 9 lbs.
- OEM console not included.





This 16 gauge steel security console features Tuffy's patented push button latch system. For safety and convenience while operating the vehicle, the lid latches closed without having to be locked. It has a spacious compartment for mounting a CD changer, storing tools, electronic equipment, cellular phones, and other valuables.

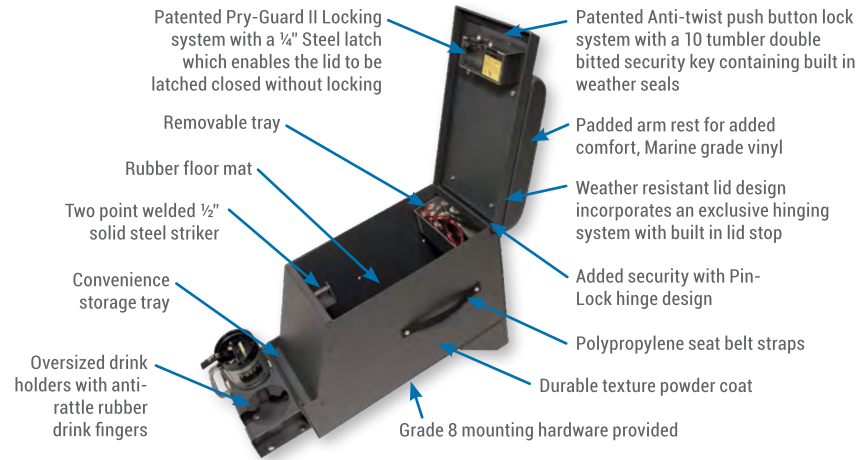

### Unsure of the size you need?

Measure at the smallest distance between your seats.



### Specifications:

**Part #:** 012  
**Colors:** Black-01, Charcoal-03 & Spice-04  
**Exterior Dimensions:** 24" L (includes cup holder) x 8" W x 18 1/2" H (includes 4" mounting bracket)  
 3 1/2" holes for drinks  
**Interior Dimensions:**  
 15 1/2" L (top), 20" L (bottom) x 7 1/2" W x 12" H



### Specifications:

**Part #:** 016  
**Colors:** Black-01 & Charcoal-03  
**Exterior Dimensions:** 24" L (includes cup holder) x 12 1/2" W x 18 1/2" H (includes 4" mounting bracket).  
 3 1/2" holes for drinks.  
**Interior Dimensions:**  
 15 1/2" L (top), 20" L (bottom) x 12" W x 12" H



### Specifications:

**Part #:** 023  
**Colors:** Black-01, Charcoal-03 & Spice-04  
**Exterior Dimensions:** 24" L (includes cup holder) x 6 1/2" W (cup holder is 8"W) x 18 1/2" H (includes 4" mounting bracket)  
 3 1/2" holes for drinks  
**Interior Dimensions:**  
 15 1/2" L (top), 20" L (bottom) x 6" W x 12" H



### Specifications:

**Part #:** 032  
**Colors:** Black-01  
**Exterior Dimensions:** 24" L (includes cup holder) x 10" W x 18 1/2" H (includes 4" mounting bracket).  
 3 1/2" holes for drinks.  
**Interior Dimensions:**  
 15 1/2" L (top), 20" L (bottom) x 9 1/2" W x 12" H

### Fits:

All vehicles with sufficient space. A variety of mounting kits are available for specific vehicle applications. Contact Tuffy Customer Service for details.  
*(Additional hardware provided by customer or modifications to hardware may be required)*

### Mounting:

Mounts through floor, drilling required (3) holes.

### Optional Accessories:

080 Finger Pull Lever | 870 Auto on/off Light  
 862 12V Power Source | 863 Gas Strut  
 034 Rear Drink Holder

### Color Options:

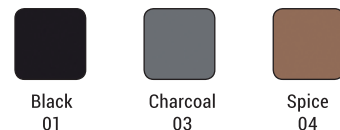

This 16 gauge steel security console has two compartments: a compartment for mounting a stereo, CB radio, or other electronic equipment; and a lockable rear storage compartment. The spacious rear compartment accommodates a CD changer, tools, and other valuables.

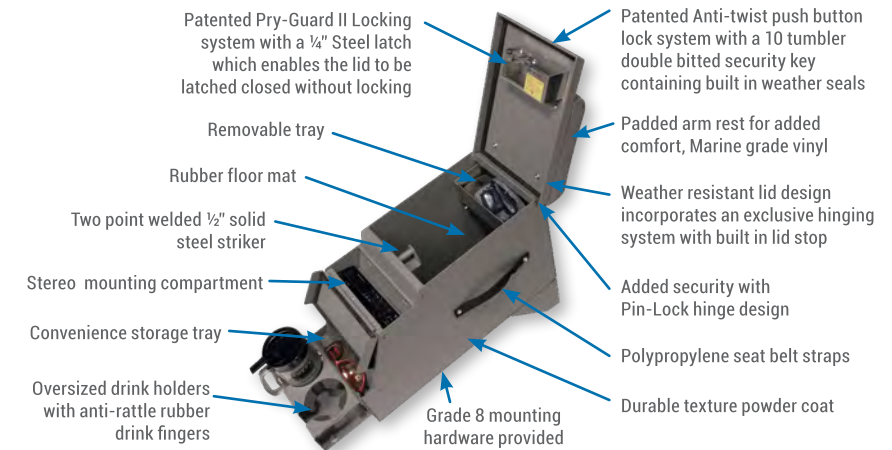

### Unsure of the size you need?

Measure at the smallest distance between your seats.



### Specifications:

**Part #:** 013  
**Colors:** Black-01, Charcoal-03 & Spice-04  
**Exterior Dimensions:** 24" L (includes cup holder) x 8" W x 18 1/2" H (includes 4" mounting bracket)  
 3 1/2" holes for drinks.  
**Interior Dimensions:**  
 12" L (top), 16" L (bottom) x 7 1/2" W x 12" H



### Specifications:

**Part #:** 017  
**Colors:** Black-01 & Charcoal-03  
**Exterior Dimensions:** 24" L (includes cup holder) x 12 1/2" W x 18 1/2" H (includes 4" mounting bracket).  
 3 1/2" holes for drinks.  
**Interior Dimensions:**  
 12" L (top), 16" L (bottom) x 12" W x 12" H



### Specifications:

**Part #:** 024  
**Colors:** Black-01 & Charcoal-03  
**Exterior Dimensions:** 24" L (includes cup holder) x 6 1/2" W (rear compartment) & 8"W (stereo compartment & cup holder) x 18 1/2" H (includes 4" mounting bracket)  
 3 1/2" holes for drinks.  
**Interior Dimensions:**  
 12" L (top), 16" L (bottom) x 6" W x 12" H



### Specifications:

**Part #:** 033  
**Colors:** Black-01 & Spice-04  
**Exterior Dimensions:** 24" L (includes cup holder) x 10" W x 18 1/2" H (includes 4" mounting bracket).  
 3 1/2" holes for drinks.  
**Interior Dimensions:**  
 12" L (top), 16" L (bottom) x 9 1/2" W x 12" H

### Fits:

All vehicles with sufficient space. A variety of mounting kits are available for specific vehicle applications. Contact Tuffy Customer Service for details.  
*(Additional hardware provided by customer or modifications to hardware may be required)*

### Stereo Compartment (All sizes):

Comes Pre-cut for DIN mount stereo 2 1/8"L x 7 1/4"W x 7"Depth, 67° Angle  
*(Stereo not Included)*

### Mounting:

Mounts through floor, drilling required (3) holes.

### Optional Accessories:

080 Finger Pull Lever | 870 Auto on/off Light  
 862 12V Power Source | 863 Gas Strut  
 034 Rear Drink Holder

### Color Options:

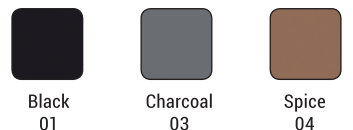



**Tuffy Security Product's Heavy Duty Gear Drawers are perfect for anyone wanting organization and heavy duty security.**

These drawers are specifically designed for outdoor use and are completely encased, producing an extremely weather resistant design.

The large drawers open smoothly on Tuffy's exclusive slide system incorporating (8) heavy duty precision stainless steel roller bearings per drawer.

They can be securely locked with Tuffy's patented locking system to provide protection for outdoor equipment and other valuables. In addition, Tuffy's Heavy Duty Gear Drawers are rated to 2000 lbs. on top.

All of Tuffy's drawers and other locking vehicle accessories can be keyed alike with a highly secure 10 Tumbler double bitted key.

**Each drawer features Tuffy's patented Pry-Guard II locking system**

which incorporates a 1/4" thick steel security latch. Unlike cabinet type drawers on the market that use retrofitted cabinet or house locks, the Tuffy drawer incorporates a patented push-button latching mechanism similar to typical OEM automotive door latches.

This type of latching system secures the drawer shut while operating the vehicle without the need to lock and unlock the drawer every time access is needed. When higher security is required, the drawer can be locked as well.



Includes one support divider per drawer. Drawer is pre-punched on 2" centers for dividers in a variety of configurations (Sold separately)

Heavy duty, space saving, bottom mount roller bearing slides feature (8) Precision ground stainless steel sealed roller bearings per drawer mounted in an innovative 1/8" thick steel slide system. Pulls out 75% and rated to 400# evenly distributed on standard drawer

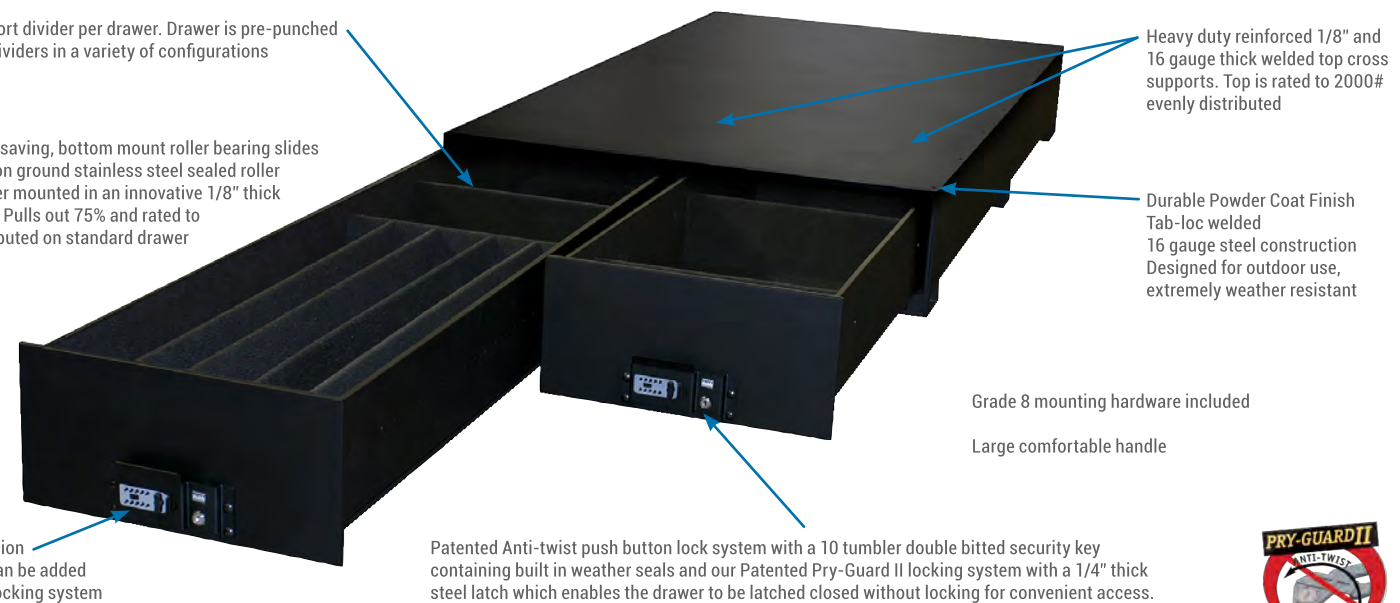

Heavy duty reinforced 1/8" and 16 gauge thick welded top cross supports. Top is rated to 2000# evenly distributed

Durable Powder Coat Finish Tab-loc welded 16 gauge steel construction Designed for outdoor use, extremely weather resistant

Grade 8 mounting hardware included  
Large comfortable handle

Optional Combination pushbutton lock can be added to the Pry-Guard locking system

Patented Anti-twist push button lock system with a 10 tumbler double bitted security key containing built in weather seals and our Patented Pry-Guard II locking system with a 1/4" thick steel latch which enables the drawer to be latched closed without locking for convenient access.



**Fits:**

Anywhere with sufficient space.

**Mounting:**

Mounts directly to flat surface with the hardware provided, drilling required.

**Specifications:**

**Part #: 257**

**Designed Short Bed Trucks:**

66" L Overall with Handle x 10"H x 47 3/4"W  
66" L Overall with Handle x 14"H x 47 3/4"W

**Designed Standard Bed Trucks:**

76" L Overall with Handle x 10"H x 47 3/4"W  
76" L Overall with Handle x 14"H x 47 3/4"W

**Designed Long Bed Trucks:**

96" L Overall with Handle x 10"H x 47 3/4"W  
96" L Overall with Handle x 14"H x 47 3/4"W

**Keyless Option Part #: 280**

This bolt on lock option offers easy access to drawers with a combination while maintaining key entry. This is a great option when access is required for multiple users. Ten push buttons can easily be set by the customer to any code. (Drawers must be pre-manufactured to accept part # 280.)





**Tablet Safe**

Weighing less than 7 lbs., this lockable welded steel storage box is designed to secure a tablet or firearm and protect valuables while carrying by hand between locations, during travel, inside a vehicle, home or office.

Convenient pre-drilled holes allow for easy mounting to solid surfaces including airline cockpits, fleet & service vehicles, home or office environments. Access ports are built in to accommodate power and data transfer cables.

Exclusive hinge stop design prevents lid from dropping open when mounted to a solid surface and can be quickly removed to open the lid fully when on the go. Keyless entry is provided by Tuffy's 3 digit combination lock with a two-point steel cam for added security.

The included 2 ft. long, 2000 pound test, steel security cable secures the safe to any sturdy mounting surface by attaching to the 1/8" steel security cable anchor point. The inside is lined with low-density foam to protect the contents, while compression bumpers keep the lid vibration-free when closed.

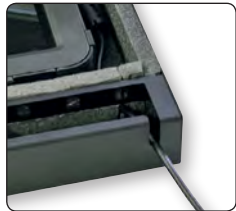

Convenient access ports



Exclusive hinge stop



1/8" Steel anchor point



Keyless entry



Steel security cable



Foam lined

**Specifications:**

**Part #:** 318  
**Color:** Black - 01  
**Exterior Dimensions Overall:** 14 1/8" L x 10 5/8" W x 1 3/4" H  
*(2.5" H including combo lock above exterior lid surface)*  
**Interior Storage Dimensions:** 13" L x 8" W x 1" H.  
**Foam Installed In Storage Area (Low-Density):** Lid: 3/4" Thick, Sides and Bottom: 3/8" Thick.  
**Lightweight:** Weighs Less Than X Lbs. *(empty without cable)*



**Fits:**

Any vehicle with sufficient space or structural mounting surface inside a home, shop or office. *(Designed to accommodate most 10" tablets; Ipad Air, Galaxy Tab S 10.5, Google Nexus 9, and larger devices like the Microsoft Surface, and 11" Macbook Air.)*

**Mounting:**

Secures to any structural mounting area with a circumference less than 2 ft. or to any flat surface using pre-drilled holes for vehicle, airplane cabin or wall mount *(using customer provided hardware)*.



**Laptop Computer Security Lock box**

The Tuffy Laptop lock box is specifically designed to provide a secure and protected place to lock up portable computers. The 1" and 2" thick foam lining protects the contents from jarring and shifting during transport. Tuffy's exclusive Pry-Guard locking system provides the high security required to protect expensive computer equipment.

The unique design incorporates an exclusive hinging system and welded steel construction. Grade 8 mounting hardware is included with mounting holes provided for bottom or back flush surface mounting so the lock box can be mounted behind the rear seat in a pickup truck or virtually any other place it can fit.

For maximum flexibility and ease of installation the lock box can be secured to the vehicle by utilizing the unique padlock mounting point to secure it to the vehicle using a standard cable. *(Padlock & cable not included)* The lid is still locked with the cam lock on top not the padlock.

In 2008, the number of reported laptop thefts rose 48% over 2007. *Source - FBI (National Crime Information Center)*

Aside from the obvious costs of replacing expensive laptop computers, one must also consider the potential exposure of sensitive information and the liability that stolen information creates. Tuffy Security Products has been manufacturing high quality security products in the USA for over 20 years.

**Specifications:**

**Part #:** 182  
**Color:** Black - 01  
**Exterior Dimensions Overall:** 18 5/16" W x 5 1/4" D x 14 1/4" H  
*(Custom sizes are also available. Call for quotes).*  
**Interior Storage Dimensions:** 15 3/4" W x 2 13/16" D x 11 1/2" H. *(Custom sizes are also available. Call for quotes).*  
**Shipping Weight:** 20 lbs.



**Fits:**

Product can be mounted in any vehicle with sufficient space. Fits most standard size laptops. *(Check laptop size before ordering.)*

**Mounting:**

No Drilling required if padlock and cable are used. Standard mounting requires drilling holes and securing with the fasteners provided.



**Conceal & Carry Tote**

Perfect for securing and transporting a handgun between the home, office and in a vehicle. The lockable welded steel storage box can be used to protect valuables both while carrying it by hand between locations and also inside a vehicle.

The included mounting sleeve is securely bolted to the vehicle or any sturdy mounting surface. The security box slides into the mounting sleeve and can be locked in place. The security box can additionally be removed from the sleeve and can remain locked closed during hand transport.



Conceal Carry Valuables Tote extra mounting sleeve can be installed in an alternate location so the lockbox can be secured in multiple locations. *(sold separately)*

The system mounts anywhere there is available space and extra sleeves are available to allow the box to be secured in a sleeve mounted in the vehicle and also in the home or office. The inside is lined with carpet to protect the contents.

Optional pick-n-pluck foam is available for additional custom sized protection around the valuables. Features Tuffy's Pry-Guard locking system with a 10 tumbler double bitted key and grade 8 mounting hardware. Optional pushbutton combo lock is available for quick keyless access to contents *(shown but sold separately)*.

**Specifications:**

**Part #:** 289  
**Color:** Black - 01  
**Exterior Dimensions Overall:** 9" L x 10"W x 3"H  
**Interior Storage Dimensions:** 63/16" L x 91/2" W x 2" H.  
**Shipping Weight:** 10 lbs.

**Fits:**

Any vehicle with sufficient space or structural mounting surface inside a home, shop or office.

**Mounting:**

Mounts in any vehicle or sturdy surface with sufficient mounting space, drilling required.

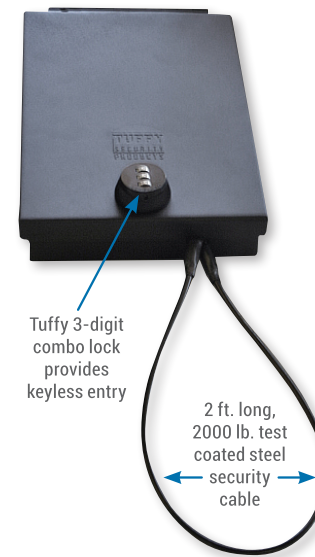

Tuffy 3-digit combo lock provides keyless entry

2 ft. long, 2000 lb. test coated steel security cable

**Portable Safe**

Weighing less than 3 or 4 lbs. respectively, these lockable welded steel storage boxes can be used to secure a firearm and protect valuables while carrying by hand between locations, during travel, inside a vehicle, home or office.

Keyless entry is provided by Tuffy's 3 digit combination lock with a two-point steel cam for added security.

The included 2 ft. long, 2000 pound test, steel security cable secures the safe to any sturdy mounting surface by attaching to the 1/8" steel security cable anchor point.

The inside is lined with low-density foam to protect the contents, while compression bumpers keep the lid vibration-free when closed.



Part #300

Part #303



**Specifications:**

**Part #:** 300  
**Color:** Black-01  
**Exterior Dimensions Overall:** 9 3/4" L x 6 1/2"W x 1 4/5"H  
*(2.5" H including combo lock above exterior lid surface)*  
**Interior Storage Dimensions (Without Foam Liner):** 7 3/4" L x 6 1/8" W x 1 3/4" H.  
**Foam Installed In Storage Area (Low-Density):**  
**Lid:** 3/4" thick. **Sides and Bottom:** 3/8" thick.

**Part #:** 303  
**Color:** Black-01  
**Exterior Dimensions Overall:** 11 3/8" L x 7 1/4"W x 1 4/5"H  
*(2.5" H including combo lock above exterior lid surface)*  
**Interior Storage Dimensions (Without Foam Liner):** 9 1/4" L x 6 7/8" W x 1 3/4" H.  
**Foam Installed In Storage Area (Low-Density):**  
**Lid, Sides and Bottom:** 3/8" thick.

**Fits:**

Any vehicle with sufficient space or structural mounting surface inside a home, shop or office.

**Mounting:**

Secures To Any Structural Mounting Area With A Circumference Less Than 2 Ft.

# TACTICAL SECURITY LOCK BOXES CUSTOM SIZES MADE TO ORDER

# TACTICAL SECURITY LOCK BOXES 3 STANDARD SIZES AVAILABLE



### Custom Sizes available

Scalable to your specifications  
Long and Short Hinge Options  
Foam and Carpet lining available  
Keyless Entry  
Part #: 327  
Color: Black - 01  
Minimum Order Quantity Required



### Slimline Size

Part #: 301  
Color: Black - 01  
Exterior Dimensions Overall:  
40"L x 12"W x 9"H (10.25" H including  
combo lock above exterior lid surface)  
Interior Storage Dimensions:  
39 5/8"L x 11 3/8"W x 9"H.  
Foam Installed In Storage Area  
(Low-Density): 3/8" Thick.



### Standard Size

Part #: 253  
Color: Black - 01  
Exterior Dimensions:  
19 7/8"W x 35 7/8"L x 8 15/16"H  
Interior Dimensions:  
19 1/4"W x 35 7/16"L x 5 3/8"(front) -  
7 9/16" H (back)



### Large Size

Part #: 278  
Color: Black - 01  
Exterior Dimensions:  
22 7/8"W x 38 7/8"L x 11 7/8"H  
Interior Dimensions:  
22 1/4"W x 38 7/16"L x 8 5/16" (front) -  
10 3/8" H (back)



Custom sizes and hinge orientations available. Minimum order quantity required on custom configurations. Call 800.348.8339 for more information.

### Portable, convenient & secure weapon and gear storage.

Tuffy's Tactical Security Lock boxes fit in any vehicle or location with sufficient space. The universal design originally created for federal law enforcement tactical personnel is now available for everyone looking for solid portable security for firearms and other valuables.

Tuffy Security Product's Tactical Security Lock-Box is state of the art in secure gear storage and organization. They are designed to be secured to the vehicle by a cable which is also secured to the Tuffy lock-box with an innovative cable-lock system (Patent rights reserved).

The unique cable locking system does not require a separate padlock and can be released in seconds to transfer the lock-box between vehicles. There are secure cable anchor points located on both sides of the lock-box so they will fit on either side of a trunk.

These highly functional and highly secure units are precision crafted from welded 16-gauge steel in the USA. The large lid opens to access a large storage space designed to accommodate an 870 shotgun, M-4 rifle and officer body armor completely outfitted.

They can be securely locked with Tuffy's exclusive locking system to provide protection for tactical equipment and other valuables. Each drawer features Tuffy's patented Pry-Guard II locking system which incorporates a 1/4" thick steel security latch. Unlike other cabinet type lock-boxes on the market that use retrofitted cabinet or house locks, the Tuffy drawer incorporates a patented push button latching mechanism similar to typical OEM automotive door latches.

A gas strut supports the lid open for easy access to the contents. The inside bottom and sides are lined with carpet to cushion items place inside. Tuffy's lock-boxes can be keyed alike with a highly secure 10 Tumbler double bitted key.

### Fits:

Any vehicle with sufficient space. Also, check to make sure the lid will clear when opened.

### Mounting:

Mounts with cable and/or padlock. (Cable and padlock not included.)

### Optional Accessories:

886 - High Security Chain & Sleeve, 5'6"  
879 - Looped End Security Cable

### Custom Lock Box Lid Configurations

#### Long Edge Access Lid



#### Short Edge Access Lid



Patented Anti-twist push button lock mechanism features a 10 tumbler double bitted security key with built in weather seals

Tuffy 10-digit combo lock provides keyless entry

Gas strut supports lid open and can be mounted on either side of the lock box for convenient access

Quick access cable securing mechanism is included securing the lock box to the vehicle. (Cable and padlock not included)

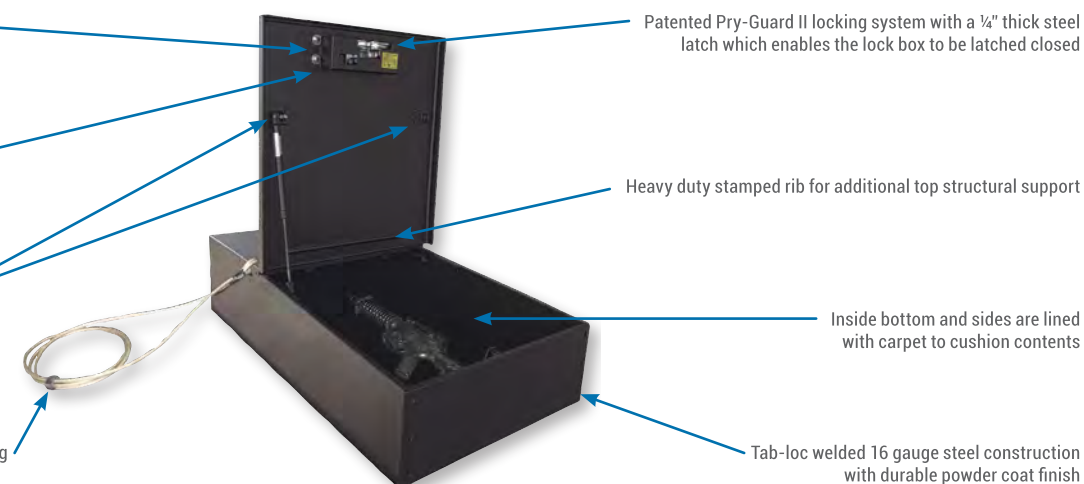

Patented Pry-Guard II locking system with a 1/4" thick steel latch which enables the lock box to be latched closed

Heavy duty stamped rib for additional top structural support

Inside bottom and sides are lined with carpet to cushion contents

Tab-loc welded 16 gauge steel construction with durable powder coat finish



Patented Anti-twist push button lock mechanism features a 10 tumbler double bitted security key.





## Ford Explorer/Interceptor SUV Under Seat Security Drawer

This high security 16 gauge steel security drawer mounts under either the driver or passenger seat in any 2011-Current Ford Explorer/Interceptor SUV. The formfitting design of this Tuffy security drawer has over 200 cubic inches of lockable storage.

It's secured contents are easily accessed by maneuvering the drawer open and closed on the smooth ball bearing slides.

Featuring Tuffy's Pry-Guard Locking System with a 10 tumbler double bitted security lock with built in weather seals. The design incorporates a heavy duty slide system, weather seal & welded construction. A formed rib in the enclosure additionally strengthens the locking system.

Mounts inconspicuously under the seat out of apparent sight of would-be thieves. Simple 2 bolt installation uses the OEM hardware with no drilling. No need to reroute under seat wiring.

Made in the USA.



Steel Construction- 11 gauge Mount Plate with Integral Lock Bracket and 16 gauge flanged lid with all fastening hardware included

Finger pull may be positioned up or down.

Pry-Guard locking system with 1/8" steel components and a 10-tumbler, double bitted security lock containing built in weather seals.

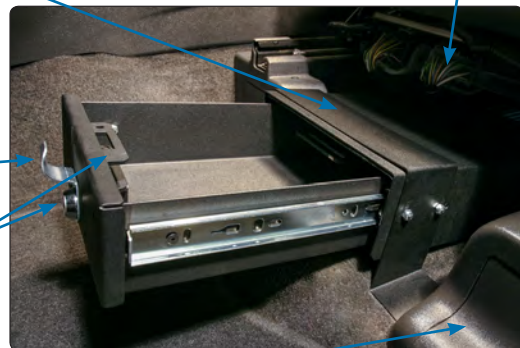

Quick and easy installation using 2 OEM seat bolts. No drilling.

### Specifications:

Part #: 335

Color: Black - 01

Exterior Dimensions Overall: 13 7/8" L x 18" W x 4 19/64" H.

Interior Volume: 200 in<sup>3</sup>

Shipping Weight: TBD lbs.

### FITS:

2011-Current Ford Explorer

2013-Current Ford Interceptor SUV

### Mounting

No drilling required. Simple 2 bolt installation uses OEM hardware.

## Universal Security Drawer

This high security 16 gauge steel security drawer mounts under the seat in any vehicle with sufficient space. Originally designed for the Ford Transit Connect, the formfitting design of this Tuffy security drawer has over 433 cubic inches of lockable storage. It's secured contents are easily accessed by maneuvering the drawer open and closed on the smooth ball bearing slides.

Featuring Tuffy's Pry-Guard Locking System with a 10 tumbler double bitted security lock with built in weather seals. The design incorporates a heavy duty slide system, weather seal & welded construction. A formed rib in the enclosure additionally strengthens the locking system.

A convenient drop slot allows depositing receipts, business cards and other items into the drawer without compromising security.

Mounts inconspicuously under the seat out of apparent sight of would-be thieves. Uses the OEM hardware without drilling in most applications. The drawer must remain locked while operating the vehicle. Made in the USA.

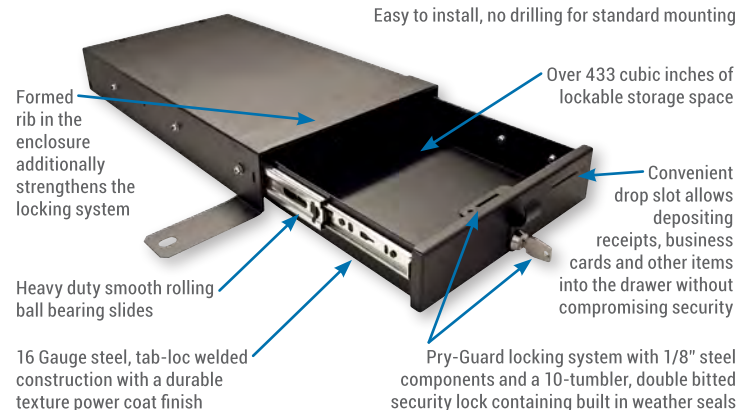

### Specifications:

Part #: 306

Color: Black - 01

Exterior Dimensions Overall: 20 1/4" L x 11 1/2" W x 3 1/4" H

Interior Dimensions: 19 1/4" L x 10" W x 2 1/4" H.

Shipping Weight: 18 lbs.

### FITS:

2003 - 2013 Ford Transit Connect or any location with sufficient space.

### Mounting

No drilling required. Fastens with original OEM hardware and included fasteners in the Ford Transit Connect.

## Factory Key Alike Service

Part #: 088

Option to have items keyed alike or to a particular key number (if available). Any type of Tuffy lock switched out at the factory.

## Follow-up Purchase Key Alike



Part #: 101 - CAM LOCKS

Part #: 102 - PUSH-BUTTON

Tuffy products can be keyed alike, both push-button and cam locks, by purchasing additional matching locks. Additional keys are also available in pairs (part #100)

## Pull Apart Key Chain



Part #: 092

Key ring disconnects to form 2 key rings allowing you to lock and unlock the console while keys are in ignition.

## Standard Drink Holder

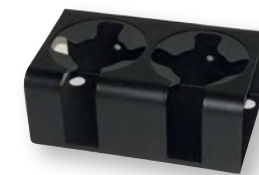

Part #: 034

Mounts to any flat surface. Great for heavy equipment, tractors, or add to the back of any Deluxe Stereo or Series II Console (holes are pre-drilled). Mounting hardware and rubber drink fingers to reduce vibration are included.

## Tuffy 7 1/2" Gas Spring Kit For Consoles



Part #: 863

This gas spring kit can be mounted on Tuffy consoles with a standard hinge. The 40# rated gas strut supports the lid open. The kit includes mounting brackets, ball studs, and fasteners.

## Tuffy Combination Lock For Cam lock



Part #: 089

Ideal when key entry is not desired. Ten push-buttons can easily be set to any code. Knob has a clutch mechanism for added security. Fits any Tuffy console with a standard cam lock mounting system and sufficient space. Not for push-button locks.

## 3-Digit Combo Cam lock



Part #: 082

Ideal when key entry is not desired. 3-digit combination can be set to any code.

## Finger Pull Lever For Push-Button Lock



Part #: 080

The steel finger pull lever is zinc plated and provides a small handle for opening and closing the lid. Mounts under push-button lock #102

## Finger Pull Lever For Cam locks:



Part #: 090

The stainless steel finger pull lever provides a small handle for opening and closing the lid. Mounts under cam lock #101.

## Lock Dust Cover:



Part #: 091

This lock cylinder dust cover is a spring loaded, plated, lock cover for cam locks to keep water, dust, etc. out of the lock. Mounts under lock.

**Interior Light**



**Part #: 099**  
This 12V light mounts anywhere inside the storage box and illuminates the inside of the box so contents can be located in dim light. Mounts inside console, drilling required, 12V wire connection.

**Auto On/Off Led Light**



**Part #: 870**  
Great for illuminating Tuffy boxes with its five LED lights. When the light switch is turned on the smart sensor detects when the lid is opened and turns on the light. Powered by 3 AA batteries (not included).  
Dimensions: 3 1/2"W x 4"L x 7/8"H

**Tuffy 12V Power Source Outlet**



**Part #: 862**  
This power outlet is rated 12V 15 amps. It provides an ideal power source location inside any Tuffy console. The outlet can also be mounted to any suitable flat surface. It requires a hinging weather resistant dust cover, mounting hardware, wire, fuse, fuse holder, terminals, and connectors required for standard installation. Cigarette lighter type plug.

**Hi-Temp Adhesive:**



**Part #: 861**  
13 oz. spray can. Excellent for installing carpet finish, Firm foam sheets and Pick 'n' pluck foam. Recommended 1 can per 32 sq. ft.

**Commercial Grade Diamond Plate Vinyl**



**Part #: 864-036 - 3' x 1' increments**  
**Part #: 864-048 - 4' x 1' increments**  
Weather resistant commercial grade 5/32" thick diamond plate vinyl matting. Various applications including covering the top of drawers or inside lining.

**Carpet For Lining Boxes:**



**Part #: 860**  
Weather resistant marine grade carpet lining. Sold per 6' wide linear foot cut to any length per foot. (6' W x 1' increments)

**Tuffy Firm Foam Sheets**



**Part #: FOAMF**  
Firm foam is a great way to protect items from damage.

**Tuffy Pick 'N' Pluck Foam**



**Part #FOAMP**  
Pick 'N' Pluck foam is a great way to protect items from damage stored inside Tuffy products. The Pick 'N' Pluck foam offers a custom fit for all your valuables. The Egg crate foam provides top protection when attached to a lid. The Pick 'N' Pluck Foam has small perforated squares that can be removed in the shape of items such as guns, cameras, etc. Base foam lines the bottom of a Tuffy box so your fragile items can be protected on all sides.

**Manufactured and Designed in the USA**

Tuffy products are manufactured by American employees at Tuffy's state-of-the-art plant located in Cortez Colorado. This gives Tuffy the ability to closely monitor the production process ensuring the customer always gets the best product on the market. This strict adherence to the highest quality standards enables Tuffy to back their products with an outstanding warranty which is unsurpassed in the industry.

Tuffy's product designs are engineered and extensively field tested at Tuffy's facility by skilled developers with years of experience. Unlike other "knock off" manufacturers who skip the design



step by stealing ideas from other companies then cheapening the product and having it manufactured overseas to maximize their profit.

Cortez is nestled on the edge of the San Juan Mountains and the slick rock desert. Along with its local gems Cortez has arguably the best trails in the world located within a 2 hour radius (Moab, Telluride, Farmington, etc.). This location allows Tuffy employees to field test prototypes, constantly improve existing products through real world use, and develop new useful and unique products through a combination of personal use and collaboration with customers out on the trails.

**Manufacturing Capabilities**

Tuffy's high-quality products along with 26 years of design and engineering expertise have forged lasting relationships with a vast amount of customers who rely on Tuffy for their manufacturing needs.

**Processes that Tuffy specializes in include:**

- Laser cutting & Automated Punching
- Precision sheet forming
- Hardware insertion
- TIG/MIG welding and finishing of carbon steel, aluminum, and stainless steel
- Powder coating with a 5 stage pretreatment process
- Full assembly line
- Complete packaging and palletizing capabilities
- Standard and special shipping options anywhere in the world

**Custom Manufacturing**

Tuffy's Law Enforcement Catalog contains only a fraction of the products Tuffy has developed and manufactured. Tuffy is constantly providing custom products to a wide variety of companies and agencies.

**Quoting Process:**

Tuffy specializes in economical runs of 25+ units. Minimum quantity is 25 (There is no minimum for Tuffy standard custom sized drawers & trunks)  
To provide you with an accurate quote, Tuffy will need detailed drawings or a sample of the desired product along with material and quantity requirements. CAD assistance is available based on an hourly rate.  
Contact the Tuffy sales department for fleet, commercial, government or industrial custom manufacturing applications.



Contract Holder  
GS-30F-0031V

Scan this code to access  
**PRO.TUFFYPRODUCTS.COM**  
on your smartphone





**SERIOUS THEFT  
PROTECTION**

25733 ROAD H  
CORTEZ, CO 81321

PHONE: 800.348.8339

LOCAL: 970.564.1762

FAX: 970.564.1783

EMAIL: SALES@TUFFYPRODUCTS.COM

You need to know that the expensive gear and supplies in your vehicle are protected but can also be at your fingertips at a moment's notice.

That's why Tuffy Security Products offers state-of-the-art secure gear organization and storage solutions that fit your needs.

# SAFEGUARD YOUR SERIOUS GEAR

Heavy duty welded steel construction built to withstand a lifetime of abuse.

You need to know that the expensive gear and supplies in your vehicle are protected but can also be at your fingertips at a moment's notice. That's why Tuffy Security Products offers state-of-the-art secure gear organization and storage solutions that fit your needs.



PRO.TUFFYPRODUCTS.COM | 866.318.8339  
PROFESSIONAL LINE PRODUCT CATALOG 14

Catalog #14. Please check local laws concerning storage of fire arms in vehicles. Tuffy reserves the right to change specifications and prices without prior notice. Tuffy Security Products, Inc. has no affiliation with the General Motors Corp., Ford Motor Company, or Chrysler. "Jeep" and "JK" are registered trademarks of Chrysler Corporation. Tuffy's product designs are protected under patent numbers 6564602, 7140649, and 7083219. Tuffy has several products which are Patent Pending. Tuffy reserves patent rights on all products developed. "Tuffy Security Products" is a Registered Trademark of Tuffy Security Products, Inc., Cortez, CO. "Pry-Guard", "Pry-Guard II", "Pin-lock", and "Anti-twist" are Trademarks of Tuffy Security Products, Inc. Copyright © 2016, Tuffy Security Products, Inc. All Rights Reserved.